



OZUBENÉ ŘEMENICE



s plným nábojem



pro pouzdro TB (Taper Bush)

Ozubené řemenice upnuté na hřídele vytváří spolu s ozubeným řemenem, kterým jsou opásány, mechanický řemenový pohon, sloužící k přenosu energie mezi jednotlivými hřídeli. Díky příčnému ozubení, které zabraňuje prokluzu, je tento pohon synchronní a lze s ním zajistit přesné časování a polohování jednotlivých hřídelů vůči sobě.

Konstrukce, provedení

Každá řemenice se vyrábí v předem stanoveném provedení (tvaru). V jakém provedení a z jakého materiálu je řemenice vyráběna najdete u každé řemenice v rozměrové řadě.

Materiál

Ozubené řemenice se vyrábí z těchto materiálů:

AL - slitina hliníku (Al, Cu, Mg, Pb)
Používané v kombinaci s PU řemeny

GG - šedá litina (GG20 - GG25)
Používané v kombinaci s CR řemeny

ST - ocel (C45)
Používané v kombinaci s CR řemeny

Vyvážení

Dynamické vyvažování má význam provádět při obvodové rychlosti, která je vyšší než 30 m/s nebo při větší hmotnosti věnce řemenice.

Normy

ISO 5294, DIN 7721 - provedení řemenic

ISO 1940, VDI 2060 - stupeň vyvážení

ISO 254 - drsnost povrchu

Typy nábojů a jejich upínání

Náboj pro pouzdro TB

Řemenice má v náboji připraven kuželový otvor pro konkrétní číslo TB pouzdra. Každé číslo pouzdra se vyrábí ve více variantách pro různé průměry hřídelí. Při objednávce TB pouzdra, které se objednává zvlášť, je nutno znát jeho číslo (součást názvu TB řemenice) a průměr hřídele, na kterou bude pouzdro nasazeno. Např. označení pouzdra TB2012-25 označuje č. pouzdra 2012 a průměr hřídele 25 mm, na kterou je možno pouzdro s řemenicí nasadit.

Při montáži se pouzdro vloží do náboje a volně, pouze ručně, se do nalicovaných otvorů našroubují montážní šrouby. Tento komplet se usadí na hřídel tak, aby pero lehce vjelo do drážky. Utahováním šroubů se pouzdro vtlačí do náboje a pevně uchytí na hřídeli. Pouzdra TB je možno použít i na hřídelích bez drážky bez použití zajišťovacího pera. Sníží se tím ale velikost maximálního přenášeného krouticího momentu.

Plný náboj

Upnutí systémem pero / drážka

Řemenice má plný náboj. Před montáží se musí v náboji vyvrtat díra se shodným průměrem, jaký má osazovaná hřídel a je také nutno vytvořit drážku pro pero. Po této přípravě se řemenice nasune na hřídel a zajistí perem. Příprava řemenice s plným nábojem je náročnější než při upínání pouzdem TB. V konstrukčně netypických nebo mini aplikacích má však použití řemenic s plným nábojem své opodstatnění.

Upnutí svěrným pouzdem

Při použití svěrného pouzdra se nepoužívá zajišťovací pero. V náboji se pouze vyvrtá válcová díra, shodná s vnějším průměrem svěrného pouzdra. Pouzdro se vloží do díry v náboji a celý komplet se nasune na hřídel. Po utažení montážních šroubů pouzdra je řemenice pevně uchycena na hřídeli.



PROVEDENÍ OSZUBENÝCH ŘEMENIC S PLNÝM NÁBOJEM

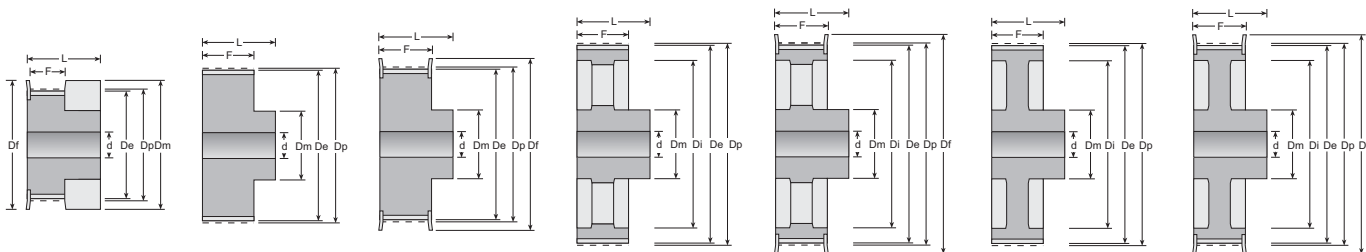

TYP 1F

TYP 6

TYP 6F

TYP 6A

TYP 6AF

TYP 6W

TYP 6WF

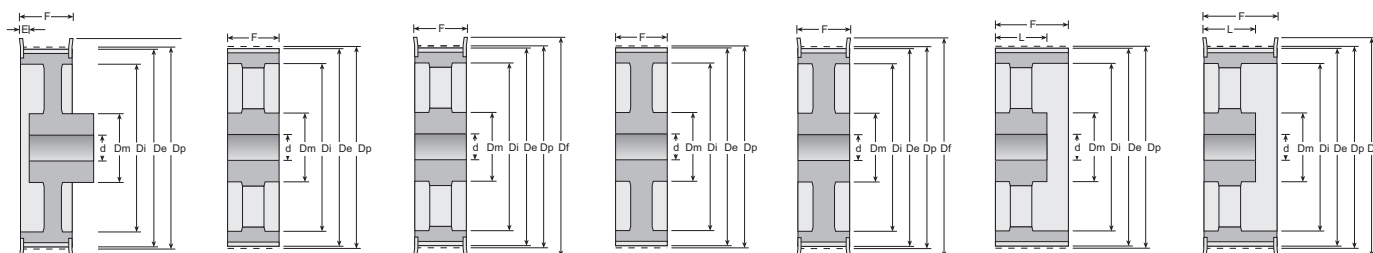

TYP 6CW

TYP 10A

TYP 10AF

TYP 10W

TYP 10WF

TYP 11A

TYP 11AF

PRO POUZDRO TB (Taper Bush)

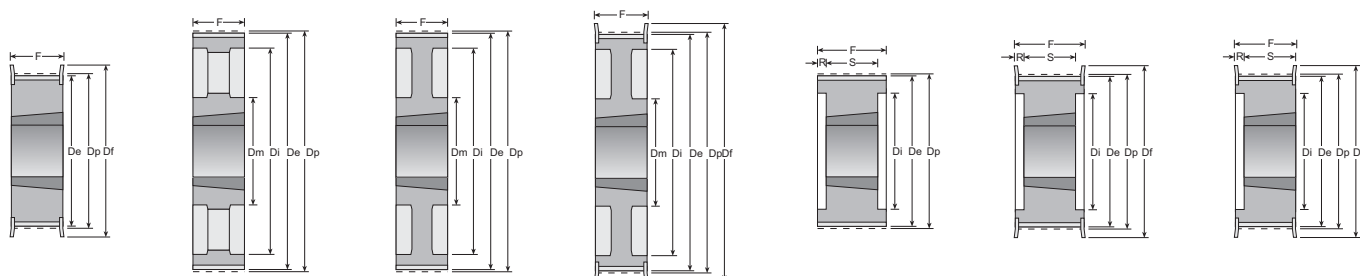

TYP 3F

TYP 3A

TYP 3W

TYP 3WF

TYP 4

TYP 4F

TYP 5F

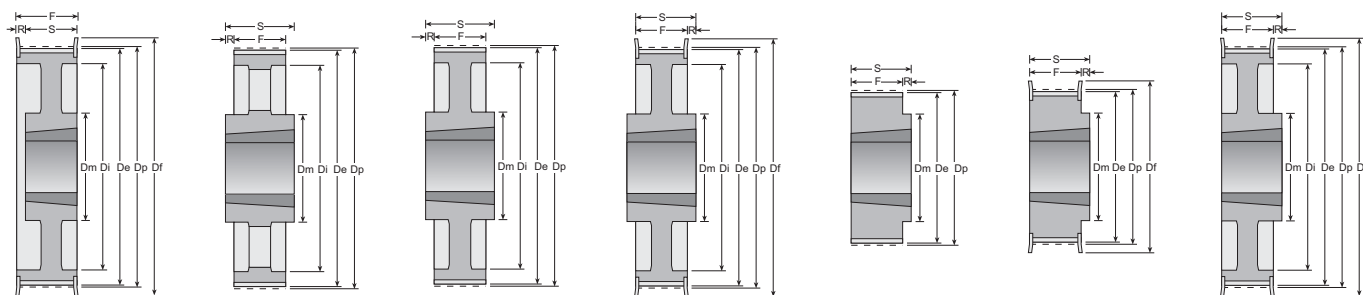

TYP 5WF

TYP 7A

TYP 7W

TYP 7WF

TYP 8

TYP 8F

TYP 8WF

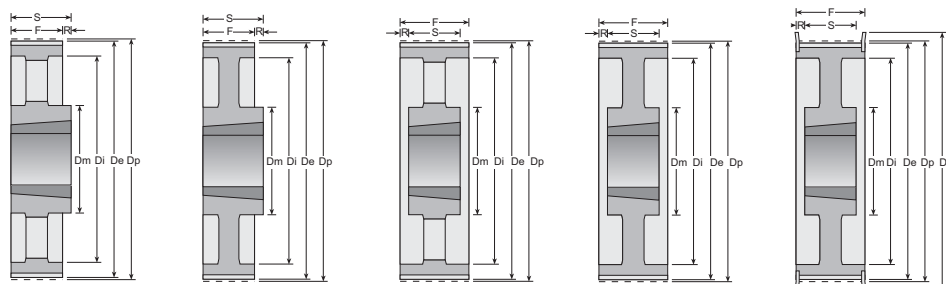

TYP 8A

TYP 8W

TYP 9A

TYP 9W

TYP 9WF



OZUBENÉ ŘEMENICE UVEDENÉ V KATALOGU

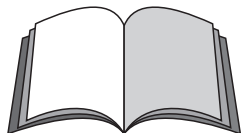

Označení řemenice	Provedení			Použitelná pro profil řemenu
	S plným nábojem	Pro pouzdro TB	Ozubená tyč	
MXL	strana 37		strana 67	MXL
XL	strana 38		strana 67	XL
L	strana 39	strana 45	strana 67	L
H	strana 41	strana 46		H
XH	strana 43			XH
XXH	strana 44			XXH
T2,5	strana 47		strana 68	T2,5
T5	strana 48		strana 68	T5
T10	strana 49		strana 69	T10
T20	strana 50			T20
AT5	strana 51		strana 69	AT5
AT10	strana 52		strana 69	AT10
AT20	strana 53			AT20
HTD 3M	strana 54		strana 70	HTD 3M, 3M GT3, STD S3M
HTD 5M	strana 55	strana 58	strana 70	HTD 5M, 5M GT3, STD S5M
HTD 8M	strana 56	strana 59	strana 70	HTD 8M, 8M GT3, STD S8M
HTD 14M	strana 57	strana 60		HTD 14M, 14M GT3, STD S14M
PCGT 8M		strana 61	strana 71	Polychain 8MGT PC
PCGT 14M		strana 62	strana 71	Polychain 14MGT PC
STD S 8M	Na poptávku	Na poptávku	Na poptávku	STD S8M*
STD S14M	Na poptávku	Na poptávku	Na poptávku	STD S14M*
Silentsync 8M	strana 63			
Silentsync 14M	strana 64			

* Řemeny STD lze použít na řemenicích HTD. Naopak řemeny HTD nelze použít na řemenicích STD.

Označení pro řemenice TB

56 8M 30 TB 2012

56 - počet zubů

8M - profil

30 - šířka řemenu (mm) nebo kód šířky

TB - řemenice pro pouzdro TB

2012 - číslo TB pouzdra pro upnutí

Označení pro řemenice s plným nebo předvrtaným nábojem

56 8M 30

56 - počet zubů

8M - profil

30 - šířka řemenu (mm) nebo kód šířky

Označení pro řemenice s vrtanou dírou

56 8M 30 - 18 H7

56 - počet zubů

8M - profil

30 - šířka řemenu (mm) nebo kód šířky

18 - průměr díry (mm)

H7 - přesnost

vrtání díry provádíme na objednávku za poplatek

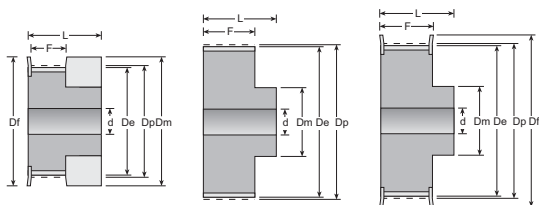
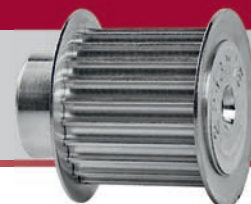

TYP 1F

TYP 6

TYP 6F

Vzor označení

16 MXL 025

Kód šířky řemenu

025 = 6,35 mm (1/4")

MXL										
Počet zubů	Kód šířky řemenu	Materiál	Typ	Dp	De	Df	Dm	F	L	d
16	025	AL	1F	10,35	9,84	15,0	15	8,5	16	-
18	025	AL	1F	11,64	11,12	16,0	16	8,5	16	-
20	025	AL	1F	12,94	12,43	16,0	16	8,5	16	-
22	025	AL	6F	14,23	13,72	17,0	10	11	16	3
24	025	AL	6F	15,52	15,01	20,0	10	11	16	3
28	025	AL	6F	18,11	17,60	25,0	11	11	16	3
30	025	AL	6F	19,40	18,90	25,0	12	11	16	4
32	025	AL	6F	20,70	20,19	26,0	14	11	16	4

Počet zubů	Kód šířky řemenu	Materiál	Typ	Dp	De	Df	Dm	F	L	d
36	025	AL	6F	23,29	22,78	28,0	16	11	16	4
40	025	AL	6F	25,87	25,37	32,0	18	11	16	4
42	025	AL	6F	27,17	26,67	32,0	18	11	16	5
44	025	AL	6F	28,48	27,95	36,0	18	11	16	5
48	025	AL	6	31,05	30,54	-	20	11	16	5
60	025	AL	6	38,81	38,30	-	24	11	16	5
72	025	AL	6	46,57	46,06	-	25	11	16	6

OZUBENÉ ŘEMENICE ZS

S PLNÝM PŘEDVRTANÝM NÁBOJEM

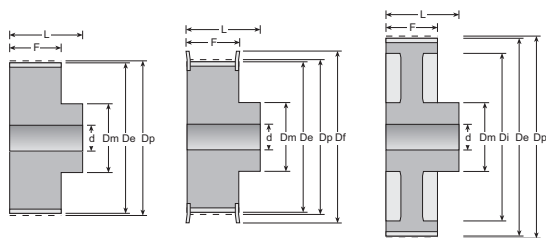

TYP 6

TYP 6F

TYP 6W

Vzor označení

10 XL 037

Kód šířky řemenu

037 = 9,53 mm (3/8")

XL										
Počet zubů	Kód šířky řemenu	Materiál	Typ	Dp	De	Df	Dm	F	L	d
10	037	ST	6F	16,17	15,66	23,0	9,5	14,3	20	-
	037	AL	6F	16,17	15,66	23,0	9,5	14,3	20	-
11	037	ST	6F	17,79	17,28	23,0	9,5	14,3	20	-
	037	AL	6F	17,79	17,28	23,0	9,5	14,3	20	-
12	037	ST	6F	19,40	18,90	25,0	10	14,3	20	-
	037	AL	6F	19,40	18,90	25,0	10	14,3	20	-
13	037	ST	6F	21,02	20,51	25,0	10	14,3	20	-
	037	AL	6F	21,02	20,51	25,0	10	14,3	20	-
14	037	ST	6F	22,64	22,13	28,0	15	14,3	20	-
	037	AL	6F	22,64	22,13	28,0	15	14,3	20	-
15	037	ST	6F	24,26	23,75	28,0	15	14,3	20	-
	037	AL	6F	24,26	23,75	28,0	15	14,3	20	-
16	037	ST	6F	25,87	25,36	32,0	16	14,3	20	-
	037	AL	6F	25,87	25,36	32,0	16	14,3	20	-
17	037	ST	6F	27,49	26,98	32,0	20	14,3	20	-
	037	AL	6F	27,49	26,98	32,0	20	14,3	20	-
18	037	ST	6F	29,11	28,60	35,0	20	14,3	20	-
	037	AL	6F	29,11	28,60	35,0	20	14,3	20	-
19	037	ST	6F	30,72	30,22	35,0	20	14,3	22	-
	037	AL	6F	30,72	30,22	35,0	20	14,3	22	-
20	037	ST	6F	32,34	31,83	38,0	23,5	14,3	22	-
	037	AL	6F	32,34	31,83	38,0	23,5	14,3	22	-
21	037	ST	6F	33,96	33,45	38,0	23,5	14,3	22	-
	037	AL	6F	33,96	33,45	38,0	23,5	14,3	22	-
22	037	ST	6F	35,57	35,07	41,0	25	14,3	22	6

Počet zubů	Kód šířky řemenu	Materiál	Typ	Dp	De	Df	Dm	F	L	d
	037	AL	6F	35,57	35,07	41,0	25	14,3	22	6
24	037	ST	6F	38,81	38,30	44,0	30	14,3	22	6
	037	AL	6F	38,81	38,30	44,0	30	14,3	22	6
26	037	ST	6F	42,04	41,53	48,0	30	14,3	22	8
	037	AL	6F	42,04	41,53	48,0	30	14,3	22	8
27	037	ST	6F	43,66	43,15	48,0	30	14,3	22	8
	037	AL	6F	43,66	43,15	48,0	30	14,3	22	8
28	037	ST	6F	45,28	44,77	51,0	34	14,3	22	8
	037	AL	6F	45,28	44,77	51,0	34	14,3	22	8
30	037	ST	6F	48,51	48,00	54,0	38	14,3	22	8
	037	AL	6F	48,51	48,00	54,0	38	14,3	22	8
32	037	ST	6F	51,74	51,24	57,0	38	14,3	25	8
	037	AL	6F	51,74	51,24	57,0	38	14,3	25	8
34	037	ST	6F	54,98	54,47	61,0	38	14,3	25	8
	037	AL	6F	54,98	54,47	61,0	38	14,3	25	8
35	037	ST	6F	56,60	56,09	61,0	38	14,3	25	8
	037	AL	6F	56,60	56,09	61,0	38	14,3	25	8
36	037	AL	6	58,21	57,70	-	45	14,3	25	8
38	037	AL	6	61,45	60,94	-	45	14,3	25	8
40	037	AL	6	64,68	64,17	-	45	14,3	25	8
42	037	AL	6	67,91	67,41	-	45	14,3	25	8
44	037	AL	6	71,15	70,64	-	45	14,3	25	8
48	037	AL	6W	77,62	77,11	-	45	14,3	25	10
60	037	AL	6W	97,02	96,51	-	45	14,3	25	10
72	037	AL	6W	116,42	115,92	-	45	14,3	25	10

OSZUBENÉ ŘEMENICE ZS

S PLNÝM PŘEDVRTANÝM NÁBOJEM

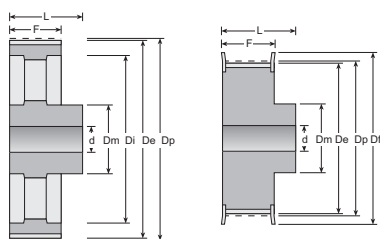

TYP 6A

TYP 6F

Vzor označení

10 L 050

Kód šířky řemenu

050 = 12,7 mm (1/2")

075 = 19,05 mm (3/4")

100 = 25,4 mm (1")

L										
Počet zubů	Kód šířky řemenu	Materiál	Typ	Dp	De	Df	Dm	F	L	d
10	050	ST	6F	30,33	29,56	37,0	20	19,0	28	8
	075	ST	6F	30,33	29,56	37,0	20	25,4	38	8
	100	ST	6F	30,33	29,56	37,0	20	31,8	45	8
11	050	ST	6F	33,35	32,59	37,0	22	19,0	30	8
	075	ST	6F	33,35	32,59	37,0	22	25,4	38	8
	100	ST	6F	33,35	32,59	37,0	22	31,8	45	8
12	050	ST	6F	36,37	35,62	43,0	24	19,0	30	8
	075	ST	6F	36,37	35,62	43,0	24	25,4	38	8
	100	ST	6F	36,37	35,62	43,0	24	31,8	45	8
13	050	ST	6F	39,41	38,65	44,0	28	19,0	30	8
	075	ST	6F	39,41	38,65	44,0	28	25,4	38	8
	100	ST	6F	39,41	38,65	44,0	28	31,8	45	8
14	050	ST	6F	42,44	41,68	48,0	28	19,0	30	8
	075	ST	6F	42,44	41,68	48,0	28	25,4	38	11
	100	ST	6F	42,44	41,68	48,0	28	31,8	45	11
15	050	ST	6F	45,48	44,72	51,0	34	19,0	30	8
	075	ST	6F	45,48	44,72	51,0	34	25,4	38	11
	100	ST	6F	45,48	44,72	51,0	34	31,8	45	11
16	050	ST	6F	48,51	47,75	54,0	36	19,0	32	8
	075	ST	6F	48,51	47,75	54,0	36	25,4	38	11
	100	ST	6F	48,51	47,75	54,0	36	31,8	45	11
17	050	ST	6F	51,54	50,78	57,0	36	19,0	32	10
	075	ST	6F	51,54	50,78	57,0	36	25,4	38	11
	100	ST	6F	51,54	50,78	57,0	36	31,8	45	11
18	050	ST	6F	54,59	53,81	60,0	40	19,0	32	10
	075	ST	6F	54,59	53,81	60,0	40	25,4	38	11
	100	ST	6F	54,59	53,81	60,0	40	31,8	45	11
19	050	ST	6F	57,61	56,84	64,0	40	19,0	32	10
	075	ST	6F	57,61	56,84	64,0	40	25,4	38	11
	100	ST	6F	57,61	56,84	64,0	40	31,8	45	11
20	050	ST	6F	60,63	59,88	66,5	40	19,0	32	10
	075	ST	6F	60,63	59,88	66,5	40	25,4	38	11
	100	ST	6F	60,63	59,88	66,5	40	31,8	45	11
21	050	ST	6F	63,68	62,91	70,0	45	19,0	32	10
	075	ST	6F	63,68	62,91	70,0	45	25,4	38	11
	100	ST	6F	63,68	62,91	70,0	45	31,8	45	11
22	050	ST	6F	66,70	65,94	75,0	45	19,0	32	10
	075	ST	6F	66,70	65,94	75,0	45	25,4	38	11
	100	ST	6F	66,70	65,94	75,0	45	31,8	45	11
23	050	ST	6F	69,73	68,97	79,0	55	19,0	32	10
	075	ST	6F	69,73	68,97	79,0	55	25,4	38	11
	100	ST	6F	69,73	68,97	79,0	55	31,8	45	11
24	050	ST	6F	72,77	72,00	79,0	55	19,0	32	10
	075	ST	6F	72,77	72,00	79,0	55	25,4	38	11
	100	ST	6F	72,77	72,00	79,0	55	31,8	45	11
25	050	ST	6F	75,80	75,04	82,5	58	19,0	32	10
	075	ST	6F	75,80	75,04	82,5	58	25,4	38	11
	100	ST	6F	75,80	75,04	82,5	58	31,8	45	11
26	050	ST	6F	78,84	78,07	86,0	58	19,0	32	11
	075	ST	6F	78,84	78,07	86,0	58	25,4	38	11
	100	ST	6F	78,84	78,07	86,0	58	31,8	45	11
27	050	ST	6F	81,86	81,10	86,0	58	19,0	32	11
	075	ST	6F	81,86	81,10	86,0	58	25,4	38	11

* Na požádání

Počet zubů	Kód šířky řemenu	Materiál	Typ	Dp	De	Df	Dm	F	L	d
10	100	ST	6F	81,86	81,10	86,0	58	31,8	45	11
	050	ST	6F	84,89	84,13	91,0	58	19,0	32	11
	075	ST	6F	84,89	84,13	91,0	58	25,4	38	11
28	100	ST	6F	84,89	84,13	91,0	58	31,8	45	11
	050	ST	6F	90,96	90,20	97,0	70	19,0	32	11
	075	ST	6F	90,96	90,20	97,0	70	25,4	38	11
30	100	ST	6F	90,96	90,20	97,0	70	31,8	45	11
	050	ST	6F	97,03	96,26	102,0	70	19,0	32	11
	075	ST	6F	97,03	96,26	102,0	70	25,4	38	11
32	100	ST	6F	97,03	96,26	102,0	70	31,8	45	11
	050	ST	6F	100,05	99,29	106,0	70	19,0	32	11
	075	ST	6F	100,05	99,29	106,0	70	25,4	38	11
33	100	ST	6F	100,05	99,29	106,0	70	31,8	45	11
	050	ST	6F	103,08	102,32	112,0	70	19,0	32	11
	075	ST	6F	103,08	102,32	112,0	70	25,4	38	11
34	100	ST	6F	103,08	102,32	112,0	70	31,8	45	11
	050	ST	6F	106,12	105,35	112,0	70	19,0	32	11
	075	ST	6F	106,12	105,35	112,0	70	25,4	38	11
35	100	ST	6F	106,12	105,35	112,0	70	31,8	45	11
	050	ST	6F	109,14	108,39	115,0	70	19,0	32	11
	075	ST	6F	109,14	108,39	115,0	70	25,4	38	11
36	100	ST	6F	109,14	108,39	115,0	70	31,8	45	11
	050	ST	6F	121,29	120,51	128,0	70	19,0	32	11
	075	ST	6F	121,29	120,51	128,0	70	25,4	38	11
40	100	ST	6F	121,29	120,51	128,0	70	31,8	45	11
	050	ST	6F	127,34	126,57	135,0	70	19,0	32	11
	075	ST	6F	127,34	126,57	135,0	70	25,4	38	11
42	100	ST	6F	127,34	126,57	135,0	70	31,8	45	11
	050	ST	6F	133,40	132,64	142,0	70	19,0	32	11
	075	ST	6F	133,40	132,64	142,0	70	25,4	38	11
44	100	ST	6F	133,40	132,64	142,0	70	31,8	45	11
	050	ST	6F	136,44	135,67	142,0	70	19,0	32	11
	075	ST	6F	136,44	135,67	142,0	70	25,4	38	11
45	100	ST	6F	136,44	135,67	142,0	70	31,8	45	11
	050	ST	6F	145,54	144,77	150,0	70	19,0	32	11
	075	ST	6F	145,54	144,77	150,0	70	25,4	38	11
48	100	ST	6F	145,54	144,77	150,0	70	31,8	45	11
	050	GG	6A	151,60	150,83	-	70	19,0	32	14
	075	GG	6A	151,60	150,83	-	70	25,4	38	14
50	100	GG	6A	151,60	150,83	-	70	31,8	45	14
	050	GG	6A	157,66	156,90	-	70	19,0	32	14
	075	GG	6A	157,66	156,90	-	70	25,4	38	14
52	100	GG	6A	157,66	156,90	-	70	31,8	45	14
	050	GG	6A	169,79	169,02	-	70	19,0	32	14
	075	GG	6A	169,79	169,02	-	70	25,4	38	14
56	100	GG	6A	169,79	169,02	-	70	31,8	45	14
	050	GG	6A	172,82	172,06	-	70	19,0	32	14
	075	GG	6A	172,82	172,06	-	70	25,4	38	14
57	100	GG	6A	172,82	172,06	-	70	31,8	45	14
	050	GG	6A	181,92	181,15	-	75	19,0	42	14
	075	GG	6A	181,92	181,15	-	75	25,4	45	14
60	100	GG	6A	181,92	181,15	-	75	31,8	45	14
	050	GG	6A	218,29	217,53	-	75	19,0	42	14
	075	GG	6A	218,29	217,53	-	75	25,4	45	14

OZUBENÉ ŘEMENICE ZS

S PLNÝM PŘEDVRTANÝM NÁBOJEM

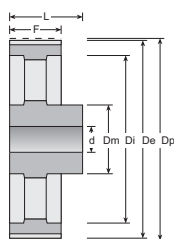

TYP 6A

Vzor označení
72 L 075

Kód šířky řemenu
050 = 12,7 mm (1/2")
075 = 19,05 mm (3/4")
100 = 25,4 mm (1")

L		POKRAČOVÁNÍ									
Počet zubů	Kód šířky řemenu	Materiál	Typ	Dp	De	Df	Dm	F	L	d	
72	075	GG	6A	218,29	217,53	-	75	25,4	45	14	
	100	GG	6A	218,29	217,53	-	75	31,8	45	14	
84	050	GG	6A	254,69	253,92	-	75	19,0	42	14	
	075	GG	6A	254,69	253,92	-	75	25,4	45	14	
	100	GG	6A	254,69	253,92	-	75	31,8	45	14	

Počet zubů	Kód šířky řemenu	Materiál	Typ	Dp	De	Df	Dm	F	L	d
96	050	GG	6A	291,06	290,30	-	75	19,0	42	14
	075	GG	6A	291,06	290,30	-	75	25,4	45	14
	100	GG	6A	291,06	290,30	-	75	31,8	45	14

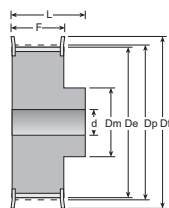

TYP 6F

Kód šířky řemenu

075 = 19,05 mm (3/4")
100 = 25,4 mm (1")
150 = 38,1 mm (1 1/2")
200 = 50,8 mm (2")
300 = 76,2 mm (3")

Vzor označení

14 H 075

H										
Počet zubů	Kód šířky řemenu	Materiál	Typ	Dp	De	Df	Dm	F	L	d
14	075	ST	6F	56,59	55,22	64,0	40	26,4	40	-
	100	ST	6F	56,59	55,22	64,0	40	31,8	45	-
	150	ST	6F	56,59	55,22	64,0	42	46,0	58	-
	200	ST	6F	56,59	55,22	64,0	42	58,7	70	-
	300	ST	6F	56,59	55,22	64,0	42	85,7	100	-
15	075	ST	6F	60,64	59,27	66,5	45	26,4	40	-
	100	ST	6F	60,64	59,27	66,5	45	31,8	45	-
	150	ST	6F	60,64	59,27	66,5	45	46,0	58	-
	200	ST	6F	60,64	59,27	66,5	45	58,7	70	-
	300	ST	6F	60,64	59,27	66,5	45	85,7	100	-
16	075	ST	6F	64,67	63,31	70,0	45	26,4	40	-
	100	ST	6F	64,67	63,31	70,0	45	31,8	45	-
	150	ST	6F	64,67	63,31	70,0	45	46,0	58	-
	200	ST	6F	64,67	63,31	70,0	45	58,7	70	-
	300	ST	6F	64,67	63,31	70,0	45	85,7	100	-
17	075	ST	6F	68,72	67,35	75,0	45	26,4	40	-
	100	ST	6F	68,72	67,35	75,0	45	31,8	45	-
	150	ST	6F	68,72	67,35	75,0	45	46,0	58	-
	200	ST	6F	68,72	67,35	75,0	45	58,7	70	-
	300	ST	6F	68,72	67,35	75,0	45	85,7	100	-
18	075	ST	6F	72,77	71,39	79,0	55	26,4	40	-
	100	ST	6F	72,77	71,39	79,0	55	31,8	45	-
	150	ST	6F	72,77	71,39	79,0	55	46,0	58	-
	200	ST	6F	72,77	71,39	79,0	55	58,7	70	-
	300	ST	6F	72,77	71,39	79,0	55	85,7	100	-
19	075	ST	6F	76,81	75,44	82,5	60	26,4	40	11
	100	ST	6F	76,81	75,44	82,5	60	31,8	45	14
	150	ST	6F	76,81	75,44	82,5	60	46,0	58	-
	200	ST	6F	76,81	75,44	82,5	60	58,7	70	-
	300	ST	6F	76,81	75,44	82,5	60	85,7	100	-
20	075	ST	6F	80,85	79,48	87,0	62	26,4	40	11
	100	ST	6F	80,85	79,48	87,0	62	31,8	45	14
	150	ST	6F	80,85	79,48	87,0	62	46,0	58	-
	200	ST	6F	80,85	79,48	87,0	62	58,7	70	-
	300	ST	6F	80,85	79,48	87,0	62	85,7	100	-
21	075	ST	6F	84,89	83,52	91,0	65	26,4	40	11
	100	ST	6F	84,89	83,52	91,0	65	31,8	45	14
	150	ST	6F	84,89	83,52	91,0	65	46,0	58	-
	200	ST	6F	84,89	83,52	91,0	65	58,7	70	-
	300	ST	6F	84,89	83,52	91,0	65	85,7	100	-
22	075	ST	6F	88,93	87,56	94,0	68	26,4	40	-
	100	ST	6F	88,93	87,56	94,0	68	31,8	45	14
	150	ST	6F	88,93	87,56	94,0	68	46,0	58	-
	200	ST	6F	88,93	87,56	94,0	68	58,7	70	-
	300	ST	6F	88,93	87,56	94,0	68	85,7	100	-
23	075	ST	6F	92,98	91,61	97,0	72	26,4	40	11
	100	ST	6F	92,98	91,61	97,0	72	31,8	45	14
	150	ST	6F	92,98	91,61	97,0	72	46,0	58	-
	200	ST	6F	92,98	91,61	97,0	72	58,7	70	-
	300	ST	6F	92,98	91,61	97,0	72	85,7	100	-
24	075	ST	6F	97,03	95,65	102,0	72	26,4	40	11
	100	ST	6F	97,03	95,65	102,0	72	31,8	45	14
	150	ST	6F	97,03	95,65	102,0	72	46,0	58	-

* Na požádání

Počet zubů	Kód šířky řemenu	Materiál	Typ	Dp	De	Df	Dm	F	L	d
200	ST	6F	97,03	95,65	102,0	72	58,7	70	-	
	300	ST	6F	97,03	95,65	102,0	72	85,7	100	-
	25	075	ST	6F	101,06	99,69	106,0	72	26,4	40
100		ST	6F	101,06	99,69	106,0	72	31,8	45	14
150		ST	6F	101,06	99,69	106,0	72	46,0	58	-
200		ST	6F	101,06	99,69	106,0	72	58,7	70	-
300		ST	6F	101,06	99,69	106,0	72	85,7	100	-
26	075	ST	6F	105,11	103,73	112,0	80	26,4	40	11
	100	ST	6F	105,11	103,73	112,0	80	31,8	45	14
	150	ST	6F	105,11	103,73	112,0	80	46,0	58	-
	200	ST	6F	105,11	103,73	112,0	80	58,7	70	-
	300	ST	6F	105,11	103,73	112,0	80	85,7	100	-
27	075	ST	6F	109,15	107,78	115,0	80	26,4	40	11
	100	ST	6F	109,15	107,78	115,0	80	31,8	45	14
	150	ST	6F	109,15	107,78	115,0	80	46,0	58	-
	200	ST	6F	109,15	107,78	115,0	80	58,7	70	-
	300	ST	6F	109,15	107,78	115,0	80	85,7	100	-
28	075	ST	6F	113,18	111,82	120,0	80	26,4	40	11
	100	ST	6F	113,18	111,82	120,0	80	31,8	45	14
	150	ST	6F	113,18	111,82	120,0	80	46,0	58	-
	200	ST	6F	113,18	111,82	120,0	80	58,7	70	-
	300	ST	6F	113,18	111,82	120,0	80	85,7	100	-
30	075	ST	6F	121,29	119,90	128,0	80	26,4	40	11
	100	ST	6F	121,29	119,90	128,0	80	31,8	45	14
	150	ST	6F	121,29	119,90	128,0	80	46,0	58	-
	200	ST	6F	121,29	119,90	128,0	80	58,7	70	-
	300	ST	6F	121,29	119,90	128,0	80	85,7	100	-
32	075	ST	6F	129,30	127,99	135,0	80	26,4	40	11
	100	ST	6F	129,30	127,99	135,0	80	31,8	45	14
	150	ST	6F	129,30	127,99	135,0	80	46,0	58	-
	200	ST	6F	129,30	127,99	135,0	80	58,7	70	-
	300	ST	6F	129,30	127,99	135,0	80	85,7	100	-
33	075	ST	6F	133,40	132,03	142,0	80	26,4	40	11
	100	ST	6F	133,40	132,03	142,0	80	31,8	45	14
	150	ST	6F	133,40	132,03	142,0	80	46,0	58	-
	200	ST	6F	133,40	132,03	142,0	80	58,7	70	-
	300	ST	6F	133,40	132,03	142,0	80	85,7	100	-
34	075	ST	6F	137,45	136,07	142,0	80	26,4	40	11
	100	ST	6F	137,45	136,07	142,0	80	31,8	45	14
	150	ST	6F	137,45	136,07	142,0	80	46,0	58	-
	200	ST	6F	137,45	136,07	142,0	80	58,7	70	-
	300	ST	6F	137,45	136,07	142,0	80	85,7	100	-
35	075	ST	6F	141,49	140,12	150,0	80	26,4	40	11
	100	ST	6F	141,49	140,12	150,0	80	31,8	45	14
	150	ST	6F	141,49	140,12	150,0	80	46,0	58	-
	200	ST	6F	141,49	140,12	150,0	80	58,7	70	-
	300	ST	6F	141,49	140,12	150,0	80	85,7	100	-
36	075	ST	6F	145,54	144,16	150,0	80	26,4	40	11
	100	ST	6F	145,54	144,16	150,0	80	31,8	45	14
	150	ST	6F	145,54	144,16	150,0	80	46,0	58	-
	200	ST	6F	145,54	144,16	150,0	80	58,7	70	-
	300	ST	6F	145,54	144,16	150,0	80	85,7	100	-
38	075	ST	6F	153,62	152,24	158,0	80	26,4	40	11

OSUZBENÉ ŘEMENICE ZS

S PLNÝM PŘEDVRTANÝM NÁBOJEM

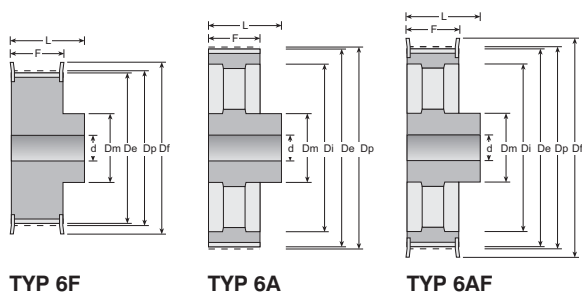

TYP 6F

TYP 6A

TYP 6AF

Kód šířky řemenu

075 = 19,05 mm (3/4")

100 = 25,4 mm (1")

150 = 38,1 mm (1 1/2")

200 = 50,8 mm (2")

300 = 76,2 mm (3")

Vzor označení

38 H 100

H POKRAČOVÁNÍ										
Počet zubů	Kód šířky řemenu	Materiál	Typ	Dp	De	Df	Dm	F	L	d
38	100	ST	6F	153,62	152,24	158,0	80	31,8	45	14
	150	ST	6F	153,62	152,24	158,0	80	46,0	58	-
	200	ST	6F	153,62	152,24	158,0	80	58,7	70	-
	300	ST	6F	153,62	152,24	158,0	80	85,7	100	-
40	075	ST	6F	161,70	160,33	168,0	80	26,4	40	11
	100	ST	6F	161,70	160,33	168,0	80	31,8	45	14
	150	ST	6F	161,70	160,33	168,0	80	46,0	58	-
	200	ST	6F	161,70	160,33	168,0	80	58,7	70	-
42	075	ST	6F	169,79	168,41	184,0	80	26,4	40	11
	100	ST	6F	169,79	168,41	180,0	80	31,8	45	14
	150	ST	6F	169,79	168,41	180,0	80	46,0	58	-
	200	ST	6F	169,79	168,41	180,0	80	58,7	70	-
44	075	GG	6AF	177,80	176,50	184,0	80	26,4	40	14
	100	GG	6AF	177,88	176,50	184,0	80	31,8	50	14
	150	GG	6AF	177,88	176,50	184,0	80	46,0	58	19
	200	GG	6AF	177,88	176,50	184,0	80	58,7	70	19
45	075	GG	6A	177,88	176,50	-	80	85,7	100	24
	100	GG	6AF	181,91	180,54	192,0	80	31,8	50	14
	150	GG	6AF	181,91	180,54	192,0	80	46,0	58	19
	200	GG	6AF	181,91	180,54	192,0	80	58,7	70	19
48	075	GG	6AF	194,03	192,67	200,0	90	26,4	45	14
	100	GG	6AF	194,03	192,67	200,0	90	31,8	50	14
	150	GG	6AF	194,03	192,67	200,0	90	46,0	65	19
	200	GG	6AF	194,03	192,67	200,0	90	58,7	75	24
50	075	GG	6A	194,03	192,67	-	90	85,7	100	24
	100	GG	6A	202,13	200,75	-	90	26,4	45	14
	150	GG	6A	202,13	200,75	-	90	31,8	50	19
	200	GG	6A	202,13	200,75	-	90	46,0	65	19
52	075	GG	6A	202,13	200,75	-	90	58,7	75	24
	100	GG	6A	202,13	200,75	-	90	85,7	100	24

Počet zubů	Kód šířky řemenu	Materiál	Typ	Dp	De	Df	Dm	F	L	d
52	100	GG	6A	210,21	208,84	-	90	31,8	50	19
	150	GG	6A	210,21	208,84	-	90	46,0	65	19
	200	GG	6A	210,21	208,84	-	90	58,7	75	24
58	100	GG	6A	234,47	233,09	-	90	31,8	50	19
	150	GG	6A	234,47	233,09	-	90	46,0	65	19
	200	GG	6A	234,47	233,09	-	90	58,7	75	24
	300	GG	6A	234,47	233,09	-	90	85,7	100	24
60	100	GG	6A	242,55	241,18	-	120	31,8	50	19
	150	GG	6A	242,55	241,18	-	120	46,0	65	19
	200	GG	6A	242,55	241,18	-	120	58,7	75	24
	300	GG	6A	242,55	241,18	-	120	85,7	100	24
70	100	GG	6A	282,98	281,61	-	120	31,8	55	19
	150	GG	6A	282,98	281,61	-	120	46,0	65	24
	200	GG	6A	282,98	281,61	-	120	58,7	75	28
	300	GG	6A	282,98	281,61	-	120	85,7	100	28
72	100	GG	6A	291,06	289,69	-	120	31,8	55	19
	150	GG	6A	291,06	289,69	-	120	46,0	65	24
	200	GG	6A	291,06	289,69	-	120	58,7	75	28
	300	GG	6A	291,06	289,69	-	120	85,7	100	28
84	100	GG	6A	339,57	338,20	-	120	31,8	55	19
	150	GG	6A	339,57	338,20	-	120	46,0	65	24
	200	GG	6A	339,57	338,20	-	120	58,7	75	28
	300	GG	6A	339,57	338,20	-	120	85,7	100	28
96	100	GG	6A	388,09	386,71	-	120	31,8	60	19
	150	GG	6A	388,09	386,71	-	120	46,0	65	24
	200	GG	6A	388,09	386,71	-	120	58,7	75	28
	300	GG	6A	388,09	386,71	-	120	85,7	100	28
120	100	GG	6A	485,12	483,73	-	120	31,8	60	19
	150	GG	6A	485,12	483,73	-	120	46,0	65	24
	200	GG	6A	485,12	483,73	-	120	58,7	75	28
	300	GG	6A	485,12	483,73	-	120	85,7	100	28

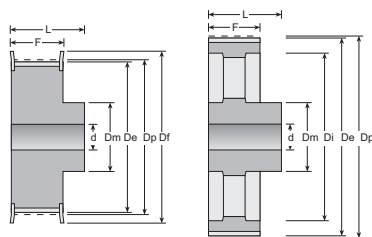

TYP 6F

TYP 6A

Vzor označení
18 XH 200

Kód šířky řemenu
200 = 50,8 mm (2")
300 = 76,2 mm (3")

XH										
Počet zubů	Kód šířky řemenu	Materiál	Typ	Dp	De	Df	Dm	F	L	d
18	200	ST	6F	127,34	124,55	140,0	100	65	80	24
	300	ST	6F	127,34	124,55	140,0	100	90,5	110	28
19	200	ST	6F	134,41	131,62	146,0	100	65	80	24
	300	ST	6F	134,41	131,62	146,0	100	90,5	110	28
20	200	ST	6F	141,49	138,69	155,0	100	65	80	24
	300	ST	6F	141,49	138,69	155,0	100	90,5	110	28
21	200	ST	6F	148,56	145,77	160,0	110	65	80	24
	300	ST	6F	148,56	145,77	160,0	110	90,5	110	28
22	200	ST	6F	155,64	152,84	170,0	110	65	80	24
	300	ST	6F	155,64	152,84	170,0	110	90,5	110	28
24	200	ST	6F	169,79	166,99	184,0	120	65	80	24
	300	ST	6F	169,79	166,99	184,0	120	90,5	110	28
25	200	ST	6F	176,86	174,07	188,0	120	65	80	24
	300	ST	6F	176,86	174,07	188,0	120	90,5	110	28
26	200	ST	6F	183,93	181,14	198,0	120	65	80	24
	300	ST	6F	183,93	181,14	198,0	120	90,5	110	28
27	200	ST	6F	191,01	188,22	205,0	120	65	80	24
	300	ST	6F	191,01	188,22	205,0	120	90,5	110	28
28	200	ST	6F	198,09	195,29	212,0	120	65	80	24
	300	ST	6F	198,09	195,29	212,0	150	90,5	110	28
30	200	ST	6F	212,23	209,44	227,0	120	65	80	24
	300	ST	6F	212,23	209,44	227,0	150	90,5	110	28

Počet zubů	Kód šířky řemenu	Materiál	Typ	Dp	De	Df	Dm	F	L	d
32	200	ST	6F	226,38	223,59	240,0	120	65	80	24
	300	ST	6F	226,38	223,59	240,0	150	90,5	110	28
34	200	ST	6F	240,53	237,74	256,0	120	65	80	24
	300	ST	6F	240,53	237,74	256,0	150	90,5	110	28
38	200	GG	6A	268,83	266,03	-	150	65	80	28
	300	GG	6A	268,83	266,03	-	150	90,5	120	32
40	200	GG	6A	282,98	280,18	-	150	65	100	28
	300	GG	6A	282,98	280,18	-	150	90,5	120	32
48	200	GG	6A	339,57	336,78	-	150	65	100	28
	300	GG	6A	339,57	336,78	-	175	90,5	120	32
60	200	GG	6A	424,47	421,67	-	150	65	100	28
	300	GG	6A	424,47	421,67	-	175	90,5	120	32
72	200	GG	6A	509,36	506,56	-	160	65	100	28
	300	GG	6A	509,36	506,56	-	175	90,5	120	32
84	200	GG	6A	594,25	591,46	-	160	65	100	28
	300	GG	6A	594,25	591,46	-	175	90,5	120	32
96	200	GG	6A	679,15	676,35	-	160	65	100	28
	300	GG	6A	679,15	676,35	-	175	90,5	120	32
120	200	GG	6A	848,93	846,14	-	160	65	100	28
	300	GG	6A	848,93	846,14	-	175	90,5	120	32

Minimální odběr řemenic s počtem zubů ≥ 34 je 10ks.

OSUBENÉ ŘEMENICE ZS

S PLNÝM PŘEDVRTANÝM NÁBOJEM

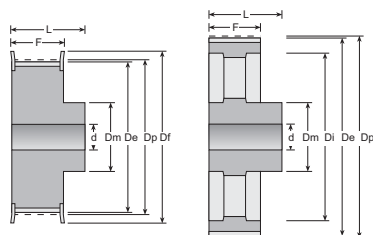

TYP 6F

TYP 6A

Vzor označení

18 XXH 200

Kód šířky řemenu

200 = 50,8 mm (2")

400 = 101,6 mm (3")

XXH										
Počet zubů	Kód šířky řemenu	Materiál	Typ	Dp	De	Df	Dm	F	L	d
18	200	ST	6F	181,91	178,87	198,0	140	64,2	100	28
	400	ST	6F	181,91	178,87	198,0	140	118,2	140	32
20	200	ST	6F	202,13	199,08	212,0	150	64,2	100	28
	400	ST	6F	202,13	199,08	212,0	150	118,2	140	32
22	200	ST	6F	222,34	219,29	240,0	150	64,2	100	28
	400	ST	6F	222,34	219,29	240,0	150	118,2	140	32
24	200	ST	6F	242,55	239,50	267,0	150	64,2	100	28
	400	ST	6F	242,55	239,50	267,0	150	118,2	140	32
26	200	ST	6F	262,76	259,79	290,0	150	64,2	100	28
	400	ST	6F	262,76	259,79	290,0	150	118,2	140	32
30	200	GG	6A	303,19	300,14	-	150	64,2	100	28
	400	GG	6A	303,19	300,14	-	185	118,2	140	32

Počet zubů	Kód šířky řemenu	Materiál	Typ	Dp	De	Df	Dm	F	L	d
40	200	GG	6A	404,25	401,21	-	150	64,2	100	28
	400	GG	6A	404,25	401,21	-	185	118,2	140	32
48	200	GG	6A	485,10	482,06	-	175	64,2	120	32
	400	GG	6A	485,10	482,06	-	185	118,2	140	38
60	200	GG	6A	606,38	603,33	-	175	64,2	120	32
	400	GG	6A	606,38	603,33	-	185	118,2	140	38
72	200	GG	6A	727,66	724,61	-	175	64,2	120	38
	400	GG	6A	727,66	724,61	-	220	118,2	140	38
90	200	GG	6A	909,57	906,52	-	175	64,2	120	38
	400	GG	6A	909,57	906,52	-	220	118,2	140	38

Minimální odběr řemenic s počtem zubů ≥ 30 je 10ks.

OSZUBENÉ ŘEMENICE ZS

PRO KUŽELOVÉ POUZDRO TB

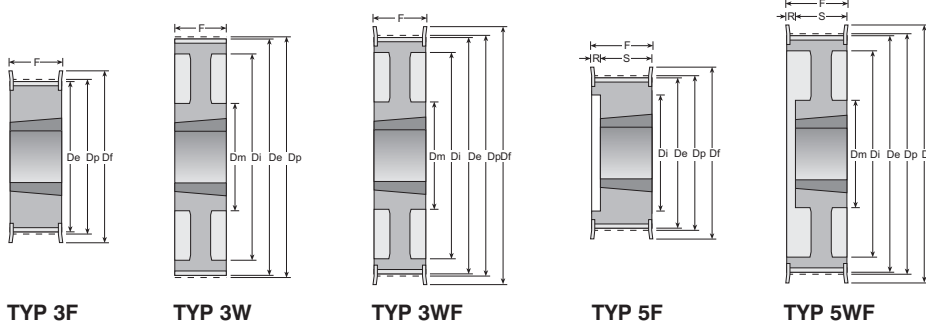

Vzor označení
18 L 050 TB 1108

Kód šířky řemenu
050 = 12,7 mm (1/2")
075 = 19,05 mm (3/4")
100 = 25,4 mm (1")

L (TB)										
Počet zubů	Kód šířky řemenu	Číslo TB pouzdra	Materiál	Typ	Dp	De	Df	Dm	F	S
18	050	1108	ST	8F	54,57	53,81	60,0	45	19,0	22,0
	075	1108	ST	3F	54,57	53,81	60,0	-	25,0	25,0
	100	1108	ST	5F	54,57	53,81	60,0	-	31,0	22,0
19	050	1108	ST	8F	57,61	56,84	64,0	45	19,0	22,0
	075	1108	ST	3F	57,61	56,84	64,0	-	25,0	25,0
	100	1108	ST	5F	57,61	56,84	64,0	-	31,0	22,0
20	050	1108	ST	8F	60,64	59,88	66,5	48	19,0	22,0
	075	1108	ST	3F	60,64	59,88	66,5	-	25,0	25,0
	100	1108	ST	5F	60,64	59,88	66,5	-	31,0	22,0
21	050	1108	ST	8F	63,67	62,91	70,0	48	19,0	22,0
	075	1108	ST	3F	63,67	62,91	70,0	-	25,0	25,0
	100	1108	ST	5F	63,67	62,91	70,0	-	31,0	22,0
22	050	1108	ST	8F	66,70	65,94	75,0	51	19,0	22,0
	075	1108	ST	3F	66,70	65,94	75,0	-	25,0	25,0
	100	1108	ST	5F	66,70	65,94	75,0	-	31,0	22,0
23	050	1108	ST	8F	69,73	68,97	79,0	54	19,0	22,0
	075	1108	ST	3F	69,73	68,97	79,0	-	25,0	25,0
	100	1108	ST	5F	69,73	68,97	79,0	-	32,0	22,0
24	050	1108	ST	8F	72,77	72,00	79,0	54	19,0	22,0
	075	1108	ST	3F	72,77	72,00	79,0	-	25,0	25,0
	100	1108	ST	5F	72,77	72,00	79,0	-	32,0	22,0
25	050	1108	ST	8F	75,80	75,04	82,5	56	19,0	22,0
	075	1108	ST	3F	75,80	75,04	82,5	-	25,0	25,0
	100	1108	ST	5F	75,80	75,04	82,5	-	32,0	22,0
26	050	1108	ST	8F	78,83	78,07	86,0	60	19,0	22,0
	075	1108	ST	3F	78,83	78,07	86,0	-	25,0	25,0
	100	1108	ST	5F	78,83	78,07	86,0	-	32,0	22,0
27	050	1108	ST	8F	81,86	81,10	86,0	62	19,0	22,0
	075	1108	ST	3F	81,86	81,10	86,0	-	25,0	25,0
	100	1108	ST	5F	81,86	81,10	86,0	-	32,0	22,0
28	050	1108	ST	8F	84,89	84,13	91,0	65	19,0	22,0
	075	1108	ST	3F	84,89	84,13	91,0	-	25,0	25,0
	100	1108	ST	5F	84,89	84,13	91,0	-	32,0	22,0

Počet zubů	Kód šířky řemenu	Číslo TB pouzdra	Materiál	Typ	Dp	De	Df	Dm	F	S
30	050	1108	ST	8F	90,96	90,20	97,0	70	19,0	22,0
	075	1108	ST	3F	90,96	90,20	97,0	-	25,0	25,0
	100	1210	ST	5F	90,96	90,20	97,0	-	32,0	25,0
32	050	1108	ST	8F	97,02	96,26	102,0	74	19,0	22,0
	075	1108	ST	3F	97,02	96,26	102,0	-	25,0	25,0
	100	1210	ST	5F	97,02	96,26	102,0	-	32,0	25,0
36	050	1108	ST	8F	109,15	108,39	115,0	85	19,0	22,0
	075	1610	ST	3F	109,15	108,39	115,0	-	25,0	25,0
	100	1610	ST	5F	109,15	108,39	115,0	-	32,0	25,0
40	050	1610	ST	8F	121,28	120,51	128,0	97	19,0	25,0
	075	1610	ST	3F	121,28	120,51	128,0	-	25,0	25,0
	100	1610	ST	5F	121,28	120,51	128,0	-	32,0	25,0
44	050	1610	ST	8WF	133,40	132,64	142,0	88	19,0	25,0
	075	1610	ST	3WF	133,40	132,64	142,0	90	25,0	25,0
	100	1610	ST	5WF	133,40	132,64	142,0	90	32,0	25,0
48	050	1610	ST	8WF	145,53	144,77	150,0	88	19,0	25,0
	075	1610	ST	3WF	145,53	144,77	150,0	92	25,0	25,0
	100	1610	ST	5WF	145,53	144,77	150,0	92	32,0	25,0
60	050	1610	GG	7W	181,91	181,15	-	92	19,0	25,0
	075	1610	GG	3W	181,91	181,15	-	92	25,0	25,0
	100	1610	GG	9W	181,91	181,15	-	92	32,0	25,0
72	050	1610	GG	7A	218,30	217,53	-	92	19,0	25,0
	075	1610	GG	3A	218,30	217,53	-	92	25,0	25,0
	100	2012	GG	3A	218,30	217,53	-	106	32,0	32,0
84	050	1610	GG	7A	254,68	253,90	-	92	19,0	25,0
	075	2012	GG	7A	254,68	253,90	-	106	25,0	32,0
	100	2012	GG	3A	254,68	253,90	-	106	32,0	32,0
96	050	2012	GG	7A	291,06	290,30	-	106	19,0	32,0
	075	2012	GG	7A	291,06	290,30	-	106	25,0	32,0
	100	2012	GG	3A	291,06	290,30	-	106	32,0	32,0
120	050	2012	GG	7A	363,83	363,07	-	106	19,0	32,0
	075	2012	GG	7A	363,83	363,07	-	106	25,0	32,0
	100	2012	GG	3A	363,83	363,07	-	106	32,0	32,0

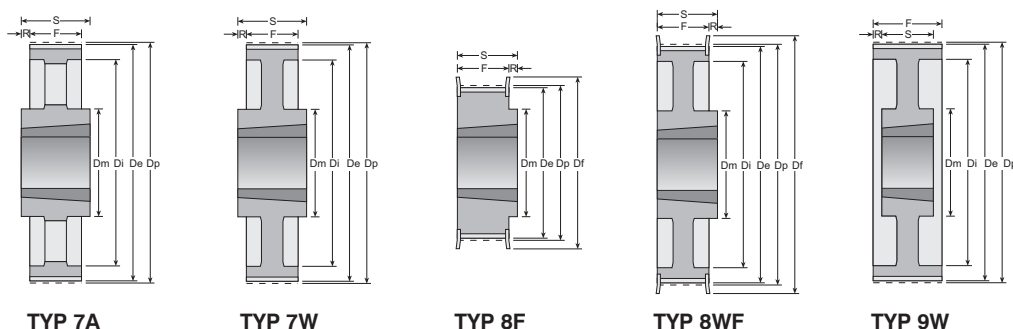

OSUBENÉ ŘEMENICE ZS

PRO KUŽELOVÉ POUZDRO TB

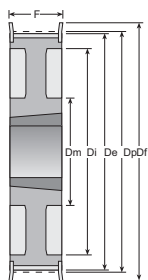

TYP 3WF

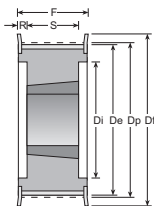

TYP 4F

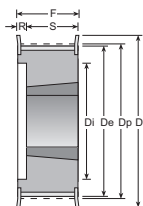

TYP 5F

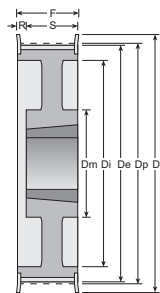

TYP 5WF

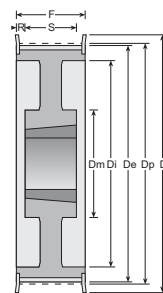

TYP 9WF

Vzor označení
16 H 100 TB 1108

Kód šířky řemenu
100 = 25,4 mm (1")
150 = 38,1 mm (1 1/2")
200 = 50,8 mm (2")
300 = 76,2 mm (3")

H (TB)										
Počet zubů	Kód šířky řemenu	Číslo TB pouzdra	Material	Typ	Dp	De	Df	Dm	F	S
16	100	1108	ST	5F	64,68	63,31	70,0	-	31,0	22,0
18	100	1210	ST	5F	72,77	71,39	79,0	-	31,0	25,0
150	1210	ST	5F	72,77	71,39	79,0	-	45,0	25,0	
200	1210	ST	5F	72,77	71,39	79,0	-	58,0	25,0	
19	100	1210	ST	5F	76,81	75,44	82,5	-	31,0	25,0
150	1210	ST	5F	76,81	75,44	82,5	-	45,0	25,0	
200	1210	ST	5F	76,81	75,44	82,5	-	58,0	25,0	
20	100	1210	ST	5F	80,55	79,48	87,0	-	31,0	25,0
150	1210	ST	5F	80,55	79,48	87,0	-	45,0	25,0	
200	1610	ST	5F	80,55	79,48	87,0	-	58,0	25,0	
300	1615	ST	4F	80,55	79,48	87,0	-	84,0	38,0	
21	100	1210	ST	5F	84,89	83,52	91,0	-	32,0	25,0
150	1210	ST	5F	84,89	83,52	91,0	-	45,0	25,0	
200	1610	ST	5F	84,89	83,52	91,0	-	58,0	25,0	
300	1615	ST	4F	84,89	83,52	91,0	-	84,0	38,0	
22	100	1210	ST	5F	88,94	87,56	94,0	-	32,0	25,0
150	1210	ST	5F	88,94	87,56	94,0	-	45,0	25,0	
200	1610	ST	5F	88,94	87,56	94,0	-	58,0	25,0	
300	1615	ST	4F	88,94	87,56	94,0	-	84,0	38,0	
23	100	1610	ST	5F	92,98	91,61	97,0	-	32,0	25,0
150	1610	ST	5F	92,98	91,61	97,0	-	45,0	25,0	
200	1610	ST	5F	92,98	91,61	97,0	-	58,0	25,0	
300	1615	ST	4F	92,98	91,61	97,0	-	84,0	38,0	
24	100	1610	ST	5F	97,02	95,65	102,0	-	32,0	25,0
150	1610	ST	5F	97,02	95,65	102,0	-	45,0	25,0	
200	1610	ST	5F	97,02	95,65	102,0	-	58,0	25,0	
300	1615	ST	4F	97,02	95,65	102,0	-	84,0	38,0	
25	100	1610	ST	5F	101,06	99,69	106,0	-	32,0	25,0
150	1610	ST	5F	101,06	99,69	106,0	-	45,0	25,0	
200	1610	ST	5F	101,06	99,69	106,0	-	58,0	25,0	
300	1615	ST	4F	101,06	99,69	106,0	-	84,0	38,0	
26	100	1610	ST	5F	105,11	103,73	112,0	-	32,0	25,0
150	1610	ST	5F	105,11	103,73	112,0	-	45,0	25,0	
200	1610	ST	5F	105,11	103,73	112,0	-	58,0	25,0	
300	1615	ST	4F	105,11	103,73	112,0	-	84,0	38,0	
27	100	1610	ST	5F	109,15	107,78	115,0	-	32,0	25,0
150	1610	ST	5F	109,15	107,78	115,0	-	45,0	25,0	
200	1610	ST	5F	109,15	107,78	115,0	-	58,0	25,0	
300	2012	ST	4F	109,15	107,78	115,0	-	84,0	32,0	
28	100	1610	ST	5F	113,19	111,82	120,0	-	32,0	25,0
150	1610	ST	5F	113,19	111,82	120,0	-	45,0	25,0	
200	1610	ST	5F	113,19	111,82	120,0	-	58,0	25,0	
300	2012	ST	4F	113,19	111,82	120,0	-	84,0	32,0	
30	100	1610	ST	5F	121,28	119,90	128,0	-	32,0	25,0
150	1610	ST	5F	121,28	119,90	128,0	-	45,0	25,0	
200	1610	ST	5F	121,28	119,90	128,0	-	58,0	25,0	
300	2012	ST	4F	121,28	119,90	128,0	-	84,0	32,0	

Počet zubů	Kód šířky řemenu	Číslo TB pouzdra	Material	Typ	Dp	De	Df	Dm	F	S
32	100	1610	ST	5WF	129,36	127,99	135,0	80	32,0	25,0
150	1610	ST	5WF	129,36	127,99	135,0	80	45,0	25,0	
200	2012	ST	5F	129,36	127,99	135,0	-	58,0	32,0	
300	2517	ST	4F	129,36	127,99	135,0	-	84,0	45,0	
36	100	1610	ST	5WF	145,53	144,16	150,0	92	32,0	25,0
150	1610	ST	5WF	145,53	144,16	150,0	92	45,0	25,0	
200	2012	ST	5WF	145,53	144,16	150,0	102	58,0	32,0	
300	2517	ST	4F	145,53	144,16	150,0	-	84,0	45,0	
40	100	1610	ST	5WF	161,70	160,33	168,0	92	32,0	25,0
150	1610	ST	5WF	161,70	160,33	168,0	92	45,0	25,0	
200	2012	ST	5WF	161,70	160,33	168,0	106	58,0	32,0	
300	2517	ST	4F	161,70	160,33	168,0	-	84,0	45,0	
44	100	2012	ST	3WF	177,87	176,50	184,0	106	32,0	32,0
150	2012	ST	5WF	177,87	176,50	184,0	106	45,0	32,0	
200	2012	ST	5WF	177,87	176,50	184,0	106	58,0	32,0	
300	2517	ST	9WF	177,87	176,50	184,0	119	86,0	45,0	
48	100	2012	ST	3WF	194,04	192,67	200,0	106	32,0	32,0
150	2012	ST	5WF	194,04	192,67	200,0	106	45,0	32,0	
200	2517	ST	5WF	194,04	192,67	200,0	119	58,0	45,0	
300	2517	ST	9WF	194,04	192,67	200,0	119	86,0	45,0	
60	100	2012	GG	9A	242,55	241,18	-	106	34,0	32,0
150	2012	GG	9A	242,55	241,18	-	106	46,0	32,0	
200	2517	GG	9A	242,55	241,18	-	119	60,0	45,0	
300	2517	GG	9A	242,55	241,18	-	119	86,0	45,0	
72	100	2012	GG	9A	291,06	289,69	-	106	34,0	32,0
150	2012	GG	9A	291,06	289,69	-	106	46,0	32,0	
200	2517	GG	9A	291,06	289,69	-	119	60,0	45,0	
300	2517	GG	9A	291,06	289,69	-	119	86,0	45,0	
84	100	2012	GG	9A	339,57	338,20	-	106	34,0	32,0
150	2012	GG	9A	339,57	338,20	-	106	46,0	32,0	
200	2517	GG	9A	339,57	338,20	-	119	60,0	45,0	
300	2517	GG	9A	339,57	338,20	-	119	86,0	45,0	
96	100	2517	GG	7A	388,08	386,71	-	119	34,0	45,0
150	2517	GG	9A	388,08	386,71	-	119	46,0	45,0	
200	2517	GG	9A	388,08	386,71	-	119	60,0	45,0	
300	3030	GG	9A	388,08	386,71	-	150	86,0	76,0	
120	100	2517	GG	7A	485,10	483,73	-	119	34,0	45,0
150	2517	GG	9A	485,10	483,73	-	119	46,0	45,0	
200	2517	GG	9A	485,10	483,73	-	119	60,0	45,0	
300	3030	GG	9A	485,10	483,73	-	150	86,0	76,0	

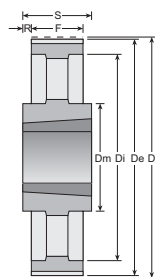

TYP 7A

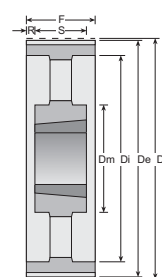

TYP 9A

OZUBENÉ ŘEMENICE T

S PLNÝM PŘEDVRTANÝM NÁBOJEM

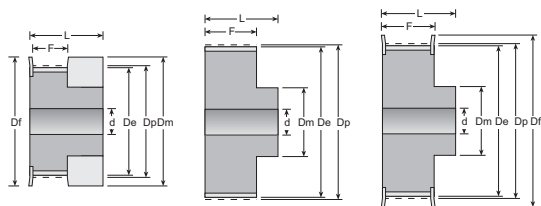
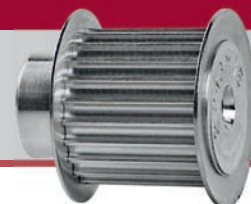

TYP 1F

TYP 6

TYP 6F

Vzor označení

16 - T2,5 - 12

kód šířky počet
šířky zubů

Kód šířky řemenu

16 = 6 mm

T2,5										
Počet zubů	Kód šířky řemenu	Materiál	Typ	Dp	De	Df	Dm	F	L	d
12	16	AL	1F	9,60	9,00	13,0	13	9	16	-
14	16	AL	1F	11,20	10,60	15,0	15	9	16	-
15	16	AL	1F	12,00	11,40	15,0	15	9	16	-
16	16	AL	1F	12,80	12,20	16,0	16	9	16	-
18	16	AL	6F	14,40	13,80	17,5	10	10	16	-
19	16	AL	6F	15,20	14,60	20,0	10	10	16	-
20	16	AL	6F	16,00	15,40	20,0	11	10	16	-
22	16	AL	6F	17,60	17,00	22,0	11	10	16	-
24	16	AL	6F	19,15	18,55	22,0	12	10	16	4
25	16	AL	6F	19,95	19,35	25,0	13	10	16	4

Počet zubů	Kód šířky řemenu	Materiál	Typ	Dp	De	Df	Dm	F	L	d
26	16	AL	6F	20,75	20,15	26,0	14	10	16	4
28	16	AL	6F	22,35	21,75	26,0	14	10	16	4
30	16	AL	6F	23,95	23,35	26,0	16	10	16	6
32	16	AL	6F	25,55	24,95	32,0	16	10	16	6
36	16	AL	6F	28,75	28,10	36,0	20	10	16	6
40	16	AL	6F	31,90	31,30	38,0	22	10	16	6
44	16	AL	6	35,10	34,50	-	24	10	16	6
48	16	AL	6	38,30	37,70	-	26	10	16	6
60	16	AL	6	47,85	47,25	-	34	10	16	8

OSZUBENÉ ŘEMENICE T

S PLNÝM PŘEDVRTANÝM NÁBOJEM

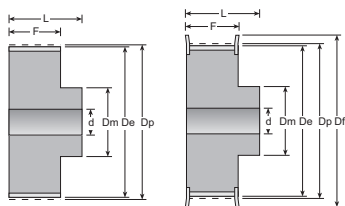

TYP 6

TYP 6F

Vzor označení

21 - T5 - 10

kód šířky počet zubů

Kód šířky řemenu

21 = 10 mm

27 = 16 mm

36 = 25 mm

T5										
Počet zubů	Kód šířky řemenu	Materiál	Typ	Dp	De	Df	Dm	F	L	d
10	21	AL	6F	15,92	15,05	19,5	8	15	21	-
27	AL	6F	15,92	15,05	19,5	8	21	27	-	-
36	AL	6F	15,92	15,05	19,5	8	30	36	-	-
12	21	AL	6F	19,10	18,25	23,0	11	15	21	-
27	AL	6F	19,10	18,25	23,0	11	21	27	-	-
36	AL	6F	19,10	18,25	23,0	11	30	36	-	-
14	21	AL	6F	22,29	21,45	25,0	13	15	21	-
27	AL	6F	22,29	21,45	25,0	13	21	27	-	-
36	AL	6F	22,29	21,45	25,0	13	30	36	-	-
15	21	AL	6F	23,88	23,05	28,0	16	15	21	6
27	AL	6F	23,88	23,05	28,0	16	21	27	6	6
36	AL	6F	23,88	23,05	28,0	16	30	36	6	6
16	21	AL	6F	25,47	24,60	32,0	18	15	21	6
27	AL	6F	25,47	24,60	32,0	18	21	27	6	6
36	AL	6F	25,47	24,60	32,0	18	30	36	6	6
18	21	AL	6F	28,65	27,80	32,0	20	15	21	6
27	AL	6F	28,65	27,80	32,0	20	21	27	6	6
36	AL	6F	28,65	27,80	32,0	20	30	36	6	6
19	21	AL	6F	30,25	29,40	36,0	22	15	21	6
27	AL	6F	30,25	29,40	36,0	22	21	27	6	6
36	AL	6F	30,25	29,40	36,0	22	30	36	6	6
20	21	AL	6F	31,83	31,00	36,0	23	15	21	6
27	AL	6F	31,83	31,00	36,0	23	21	27	6	6
36	AL	6F	31,83	31,00	36,0	23	30	36	6	6
22	21	AL	6F	35,02	34,15	38,0	24	15	21	6
27	AL	6F	35,02	34,15	38,0	24	21	27	6	6
36	AL	6F	35,02	34,15	38,0	24	30	36	6	6
24	21	AL	6F	38,21	37,40	42,0	26	15	21	6
27	AL	6F	38,21	37,40	42,0	26	21	27	6	6
36	AL	6F	38,21	37,40	42,0	26	30	36	8	8
25	21	AL	6F	39,80	39,00	44,0	26	15	21	6
27	AL	6F	39,80	39,00	44,0	26	21	27	6	6
36	AL	6F	39,80	39,00	44,0	26	30	36	8	8

Počet zubů	Kód šířky řemenu	Materiál	Typ	Dp	De	Df	Dm	F	L	d
26	21	AL	6F	41,39	40,60	44,0	26	15	21	6
27	AL	6F	41,39	40,60	44,0	26	21	27	6	6
36	AL	6F	41,39	40,60	44,0	26	30	36	8	8
27	21	AL	6F	42,98	42,20	48,0	30	15	21	8
27	AL	6F	42,98	42,20	48,0	30	21	27	8	8
36	AL	6F	42,98	42,20	48,0	30	30	36	8	8
28	21	AL	6F	44,58	43,75	48,0	32	15	21	8
27	AL	6F	44,58	43,75	48,0	32	21	27	8	8
36	AL	6F	44,58	43,75	48,0	32	30	36	8	8
30	21	AL	6F	47,76	46,95	51,0	34	15	21	8
27	AL	6F	47,76	46,95	51,0	34	21	27	8	8
36	AL	6F	47,76	46,95	51,0	34	30	36	8	8
32	21	AL	6F	50,94	50,10	54,0	38	15	21	8
27	AL	6F	50,94	50,10	54,0	38	21	27	8	8
36	AL	6F	50,94	50,10	54,0	38	30	36	8	8
36	21	AL	6F	57,31	56,45	64,0	38	15	21	8
27	AL	6F	57,31	56,45	64,0	38	21	27	8	8
36	AL	6F	57,31	56,45	64,0	38	30	36	8	8
40	21	AL	6F	63,66	62,85	66,5	40	15	21	8
27	AL	6F	63,66	62,85	66,5	40	21	27	8	8
36	AL	6F	63,66	62,85	66,5	40	30	36	8	8
42	21	AL	6F	66,86	66,00	70,0	40	15	21	8
27	AL	6F	66,86	66,00	70,0	40	21	27	8	8
36	AL	6F	66,86	66,00	70,0	40	30	36	8	8
44	21	AL	6	70,05	69,20	-	45	15	21	8
27	AL	6	70,05	69,20	-	45	21	27	8	8
36	AL	6	70,05	69,20	-	45	30	36	8	8
48	21	AL	6	76,42	75,55	-	50	15	21	8
27	AL	6	76,42	75,55	-	50	21	27	8	8
36	AL	6	76,42	75,55	-	50	30	36	8	8
60	21	AL	6	95,52	94,65	-	65	15	21	8
27	AL	6	95,52	94,65	-	65	21	27	8	8
36	AL	6	95,52	94,65	-	65	30	36	8	8

OSZUBENÉ ŘEMENICE T

S PLNÝM PŘEDVRTANÝM NÁBOJEM

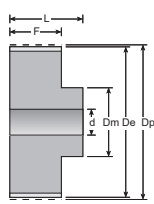

TYP 6

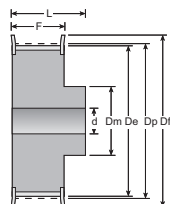

TYP 6F

Vzor označení

31 - T10 - 12

kód
šířky

počet
zubů

Kód šířky řemenu

31 = 16 mm

40 = 25 mm

47 = 32 mm

66 = 50 mm

T10										
Počet zubů	Kód šířky řemenu	Materiál	Typ	Dp	De	Df	Dm	F	L	d
12	31	AL	6F	38,20	36,35	42,0	28	21	31	6
	40	AL	6F	38,20	36,35	42,0	28	30	40	6
14	31	AL	6F	44,56	42,70	48,0	32	21	31	8
	40	AL	6F	44,56	42,70	48,0	32	30	40	8
15	31	AL	6F	47,75	45,90	51,0	32	21	31	8
	40	AL	6F	47,75	45,90	51,0	32	30	40	8
16	31	AL	6F	50,93	49,10	54,0	35	21	30	8
	40	AL	6F	50,93	49,10	54,0	35	30	40	8
18	31	AL	6F	57,29	55,45	60,0	40	21	31	8
	40	AL	6F	57,29	55,45	60,0	40	30	40	8
	47	AL	6F	57,29	55,45	60,0	40	37	47	10
	66	AL	6F	57,29	55,45	60,0	40	56	66	10
19	31	AL	6F	60,48	58,65	66,0	44	21	31	8
	40	AL	6F	60,48	58,65	66,0	44	30	40	8
	47	AL	6F	60,48	58,65	66,0	44	37	47	10
	66	AL	6F	60,48	58,65	66,0	44	56	66	10
20	31	AL	6F	63,66	61,80	66,0	46	21	31	8
	40	AL	6F	63,66	61,80	66,0	46	30	40	8
	47	AL	6F	63,66	61,80	66,0	46	37	47	12
	66	AL	6F	63,66	61,80	66,0	46	56	66	12
22	31	AL	6F	70,03	68,20	75,0	52	21	31	8
	40	AL	6F	70,03	68,20	75,0	52	30	40	8
	47	AL	6F	70,03	68,20	75,0	52	37	47	12
	66	AL	6F	70,03	68,20	75,0	52	56	66	12
24	31	AL	6F	76,39	74,55	83,0	58	21	31	8
	40	AL	6F	76,39	74,55	83,0	58	30	40	8
	47	AL	6F	76,39	74,55	83,0	58	37	47	12
	66	AL	6F	76,39	74,55	83,0	58	56	66	12
25	31	AL	6F	79,58	77,75	83,0	60	21	31	8
	40	AL	6F	79,58	77,75	83,0	60	30	40	8
	47	AL	6F	79,58	77,75	83,0	60	37	47	12
	66	AL	6F	79,58	77,75	83,0	60	56	66	12
26	31	AL	6F	82,76	80,90	87,0	60	21	31	8
	40	AL	6F	82,76	80,90	87,0	60	30	40	8
	47	AL	6F	82,76	80,90	87,0	60	37	47	12
	66	AL	6F	82,76	80,90	87,0	60	56	66	12

Počet zubů	Kód šířky řemenu	Materiál	Typ	Dp	De	Df	Dm	F	L	d
27	31	AL	6F	85,95	84,10	91,0	60	21	31	8
	40	AL	6F	85,95	84,10	91,0	60	30	40	8
	47	AL	6F	85,95	84,10	91,0	60	37	47	12
	66	AL	6F	85,95	84,10	91,0	60	56	66	12
28	31	AL	6F	89,12	87,25	93,0	60	21	31	8
	40	AL	6F	89,12	87,25	93,0	60	30	40	8
	47	AL	6F	89,12	87,25	93,0	60	37	47	12
	66	AL	6F	89,12	87,25	93,0	60	56	66	12
30	31	AL	6F	95,49	93,65	102,0	60	21	31	8
	40	AL	6F	95,49	93,65	102,0	60	30	40	8
	47	AL	6F	95,49	93,65	102,0	60	37	47	12
	66	AL	6F	95,49	93,65	102,0	60	56	66	12
32	31	AL	6F	101,86	100,00	106,0	65	21	31	10
	40	AL	6F	101,86	100,00	106,0	65	30	40	10
	47	AL	6F	101,86	100,00	106,0	65	37	47	12
	66	AL	6F	101,86	100,00	106,0	65	56	66	12
36	31	AL	6F	114,59	112,75	119,0	70	21	31	10
	40	AL	6F	114,59	112,75	119,0	70	30	40	10
	47	AL	6F	114,59	112,75	119,0	70	37	47	16
	66	AL	6F	114,59	112,75	119,0	70	56	66	16
40	31	AL	6F	127,32	125,45	131,0	80	21	31	10
	40	AL	6F	127,32	125,45	131,0	80	30	40	10
	47	AL	6F	127,32	125,45	131,0	80	37	47	16
	66	AL	6F	127,32	125,45	131,0	80	56	66	16
44	31	AL	6	140,05	138,20	-	88	21	31	10
	40	AL	6	140,05	138,20	-	88	30	40	10
	47	AL	6	140,05	138,20	-	88	37	47	16
	66	AL	6	140,05	138,20	-	88	56	66	16
48	31	AL	6	152,78	150,95	-	95	21	31	16
	40	AL	6	152,78	150,95	-	95	30	40	16
	47	AL	6	152,78	150,95	-	95	37	47	16
	66	AL	6	152,78	150,95	-	95	56	66	16
60	31	AL	6	190,98	189,10	-	110	21	31	16
	40	AL	6	190,98	189,10	-	110	30	40	16
	47	AL	6	190,98	189,10	-	110	37	47	16
	66	AL	6	190,98	189,10	-	110	56	66	16

OSUBENÉ ŘEMENICE T

S PLNÝM PŘEDVRTANÝM NÁBOJEM

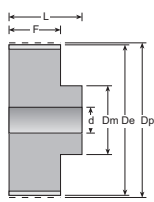

TYP 6

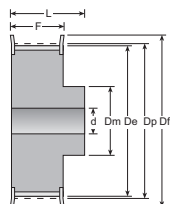

TYP 6F

Vzor označení

53 - T20 - 18

kód šířky počet zubů

Kód šířky řemenu

53 = 32 mm

71 = 50 mm

123 = 100 mm

T20										
Počet zubů	Kód šířky řemenu	Materiál	Typ	Dp	De	Df	Dm	F	L	d
18	53	AL	6F	114,59	111,75	120,0	80	38	53	15
	71	AL	6F	114,59	111,75	120,0	80	56	71	18
	123	AL	6F	114,59	111,75	120,0	80	108	123	24
20	53	AL	6F	127,32	124,50	138,0	90	38	53	15
	71	AL	6F	127,32	124,50	138,0	90	56	71	18
	123	AL	6F	127,32	124,50	138,0	90	108	123	24
22	53	AL	6F	140,06	137,20	146,0	90	38	53	15
	71	AL	6F	140,06	137,20	146,0	90	56	71	18
	123	AL	6F	140,06	137,20	146,0	90	108	123	24
24	53	AL	6F	152,79	149,95	158,0	95	38	53	15
	71	AL	6F	152,79	149,95	158,0	95	56	71	18
	123	AL	6F	152,79	149,95	158,0	95	108	123	24
25	53	AL	6F	159,15	156,30	168,0	95	38	53	15
	71	AL	6F	159,15	156,30	168,0	95	56	71	18
	123	AL	6F	159,15	156,30	168,0	95	108	123	24
30	53	AL	6F	190,99	188,15	200,0	110	38	53	15
	71	AL	6F	190,99	188,15	200,0	110	56	71	18
	123	AL	6F	190,99	188,15	200,0	110	108	123	24

Počet zubů	Kód šířky řemenu	Materiál	Typ	Dp	De	Df	Dm	F	L	d
32	53	AL	6	203,72	200,85	-	110	38	53	18
	71	AL	6	203,72	200,85	-	110	56	71	20
	123	AL	6	203,72	200,85	-	110	108	123	32
36	53	AL	6	229,18	226,35	-	110	38	53	18
	71	AL	6	229,18	226,35	-	110	56	71	20
	123	AL	6	229,18	226,35	-	110	108	123	32
40	53	AL	6	254,65	251,80	-	110	38	53	20
	71	AL	6	254,65	251,80	-	110	56	71	20
	123	AL	6	254,65	251,80	-	110	108	123	32
48	53	AL	6	305,58	302,70	-	130	38	53	20
	71	AL	6	305,58	302,70	-	130	56	71	24
	123	AL	6	305,58	302,70	-	130	108	123	32
60	53	AL	6	381,97	379,10	-	130	38	53	20
	71	AL	6	381,97	379,10	-	130	56	71	24
	123	AL	6	381,97	379,10	-	130	108	123	32
72	53	AL	6	458,37	455,50	-	140	38	53	20
	71	AL	6	458,37	455,50	-	140	56	71	24
	123	AL	6	458,37	455,50	-	140	108	123	32

Všechny řemenice T20, včetně rozměrů zde neuvedených, dodáváme pouze na poptávku.

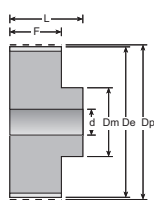

TYP 6

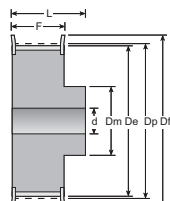

TYP 6F

Vzor označení

21 - AT5 - 12

kód
šířky

počet
zubů

Kód šířky řemenu

21 = 10 mm

27 = 16 mm

36 = 25 mm

AT5										
Počet zubů	Kód šířky řemenu	Materiál	Typ	Dp	De	Df	Dm	F	L	d
12	21	AL	6F	19,10	17,85	23,0	11	15	21	-
27	AL	6F	19,10	17,85	23,0	11	21	27	-	-
36	AL	6F	19,10	17,85	23,0	11	30	36	-	-
14	21	AL	6F	22,29	21,05	25,0	13	15	21	-
27	AL	6F	22,29	21,05	25,0	13	21	27	-	-
36	AL	6F	22,29	21,05	25,0	13	30	36	-	-
15	21	AL	6F	23,88	22,65	28,0	16	15	21	6
27	AL	6F	23,88	22,65	28,0	16	21	27	6	6
36	AL	6F	23,88	22,65	28,0	16	30	36	6	6
16	21	AL	6F	25,47	24,20	32,0	18	15	21	6
27	AL	6F	25,47	24,20	32,0	18	21	27	6	6
36	AL	6F	25,47	24,20	32,0	18	30	36	6	6
18	21	AL	6F	28,65	27,40	32,0	20	15	21	6
27	AL	6F	28,65	27,40	32,0	20	21	27	6	6
36	AL	6F	28,65	27,40	32,0	20	30	36	6	6
19	21	AL	6F	30,25	29,00	36,0	22	15	21	6
27	AL	6F	30,25	29,00	36,0	22	21	27	6	6
36	AL	6F	30,25	29,00	36,0	22	30	36	6	6
20	21	AL	6F	31,83	30,60	36,0	23	15	21	6
27	AL	6F	31,83	30,60	36,0	23	21	27	6	6
36	AL	6F	31,83	30,60	36,0	23	30	36	6	6
22	21	AL	6F	35,02	33,85	38,0	24	15	21	6
27	AL	6F	35,02	33,85	38,0	24	21	27	6	6
36	AL	6F	35,02	33,85	38,0	24	30	36	6	6
24	21	AL	6F	38,21	37,00	42,0	26	15	21	6
27	AL	6F	38,21	37,00	42,0	26	21	27	6	6
36	AL	6F	38,21	37,00	42,0	26	30	36	6	6
25	21	AL	6F	39,80	38,60	44,0	26	15	21	6
27	AL	6F	39,80	38,60	44,0	26	21	27	6	6
36	AL	6F	39,80	38,60	44,0	26	30	36	6	6
26	21	AL	6F	41,39	40,20	44,0	26	15	21	6
27	AL	6F	41,39	40,20	44,0	26	21	27	6	6
36	AL	6F	41,39	40,20	44,0	26	30	36	6	6

Počet zubů	Kód šířky řemenu	Materiál	Typ	Dp	De	Df	Dm	F	L	d
27	21	AL	6F	42,98	41,80	48,0	30	15	21	8
27	AL	6F	42,98	41,80	48,0	30	21	27	8	8
36	AL	6F	42,98	41,80	48,0	30	30	36	8	8
28	21	AL	6F	44,58	43,35	48,0	32	15	21	8
27	AL	6F	44,58	43,35	48,0	32	21	27	8	8
36	AL	6F	44,58	43,35	48,0	32	30	36	8	8
30	21	AL	6F	47,76	46,55	51,0	34	15	21	8
27	AL	6F	47,76	46,55	51,0	34	21	27	8	8
36	AL	6F	47,76	46,55	51,0	34	30	36	8	8
32	21	AL	6F	50,94	49,70	54,0	38	15	21	8
27	AL	6F	50,94	49,70	54,0	38	21	27	8	8
36	AL	6F	50,94	49,70	54,0	38	30	36	8	8
36	21	AL	6F	57,31	56,05	64,0	38	15	21	8
27	AL	6F	57,31	56,05	64,0	38	21	27	8	8
36	AL	6F	57,31	56,05	64,0	38	30	36	8	8
40	21	AL	6F	63,66	62,45	66,5	40	15	21	8
27	AL	6F	63,66	62,45	66,5	40	21	27	8	8
36	AL	6F	63,66	62,45	66,5	40	30	36	8	8
42	21	AL	6F	66,86	65,60	70,0	40	15	21	8
27	AL	6F	66,86	65,60	70,0	40	21	27	8	8
36	AL	6F	66,86	65,60	70,0	40	30	36	8	8
44	21	AL	6	70,05	68,80	-	45	15	21	8
27	AL	6	70,05	68,80	-	45	21	27	8	8
36	AL	6	70,05	68,80	-	45	30	36	8	8
48	21	AL	6	76,42	75,15	-	50	15	21	8
27	AL	6	76,42	75,15	-	50	21	27	8	8
36	AL	6	76,42	75,15	-	50	30	36	8	8
60	21	AL	6	95,52	94,25	-	65	15	21	8
27	AL	6	95,52	94,25	-	65	21	27	8	8
36	AL	6	95,52	94,25	-	65	30	36	8	8

OSUBENÉ ŘEMENICE AT

S PLNÝM PŘEDVRTANÝM NÁBOJEM

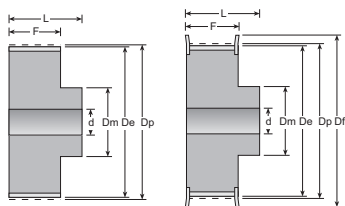

TYP 6

TYP 6F

Kód šířky řemenu

31 = 16 mm

40 = 25 mm

47 = 32 mm

66 = 50 mm

Vzor označení

31 - AT10 - 15

kód šířky *počet zubů*

AT10										
Počet zubů	Kód šířky řemenu	Materiál	Typ	Dp	De	Df	Dm	F	L	d
15	31	AL	6F	47,75	45,90	51,0	32	21	31	8
40	AL	6F	47,75	45,90	51,0	32	30	40	8	
16	31	AL	6F	50,93	49,05	54,0	35	21	31	8
40	AL	6F	50,93	49,05	54,0	35	30	40	8	
18	31	AL	6F	57,29	55,45	60,0	40	21	31	8
40	AL	6F	57,29	55,45	60,0	40	30	40	8	
47	AL	6F	57,29	55,45	60,0	40	37	47	10	
66	AL	6F	57,29	55,45	60,0	40	56	66	10	
19	31	AL	6F	60,48	58,60	66,5	44	21	31	8
40	AL	6F	60,48	58,60	66,5	44	30	40	8	
47	AL	6F	60,48	58,60	66,5	44	37	47	10	
66	AL	6F	60,48	58,60	66,5	44	56	66	10	
20	31	AL	6F	63,66	61,80	66,5	46	21	31	8
40	AL	6F	63,66	61,80	66,5	46	30	40	8	
47	AL	6F	63,66	61,80	66,5	46	37	47	12	
66	AL	6F	63,66	61,80	66,5	46	56	66	12	
22	31	AL	6F	70,03	68,15	75,0	52	21	31	8
40	AL	6F	70,03	68,15	75,0	52	30	40	8	
47	AL	6F	70,03	68,15	75,0	52	37	47	12	
66	AL	6F	70,03	68,15	75,0	52	56	66	12	
24	31	AL	6F	76,39	74,55	83,0	58	21	31	8
40	AL	6F	76,39	74,55	83,0	58	30	40	8	
47	AL	6F	76,39	74,55	83,0	58	37	47	12	
66	AL	6F	76,39	74,55	83,0	58	56	66	12	
25	31	AL	6F	79,58	77,70	83,0	60	21	31	8
40	AL	6F	79,58	77,70	83,0	60	30	40	8	
47	AL	6F	79,58	77,70	83,0	60	37	47	12	
66	AL	6F	79,58	77,70	83,0	60	56	66	12	
26	31	AL	6F	82,76	80,90	87,0	60	21	31	8
40	AL	6F	82,76	80,90	87,0	60	30	40	8	
47	AL	6F	82,76	80,90	87,0	60	37	47	12	
66	AL	6F	82,76	80,90	87,0	60	56	66	12	
27	31	AL	6F	85,95	84,10	91,0	60	21	31	8
40	AL	6F	85,95	84,10	91,0	60	30	40	8	
47	AL	6F	85,95	84,10	91,0	60	37	47	12	
66	AL	6F	85,95	84,10	91,0	60	56	66	12	

Počet zubů	Kód šířky řemenu	Materiál	Typ	Dp	De	Df	Dm	F	L	d
28	31	AL	6F	89,12	87,25	93,0	60	21	31	8
40	AL	6F	89,12	87,25	93,0	60	30	40	8	
47	AL	6F	89,12	87,25	93,0	60	37	47	12	
66	AL	6F	89,12	87,25	93,0	60	56	66	12	
30	31	AL	6F	95,49	93,65	102,0	60	21	31	8
40	AL	6F	95,49	93,65	102,0	60	30	40	8	
47	AL	6F	95,49	93,65	102,0	60	37	47	12	
66	AL	6F	95,49	93,65	102,0	60	56	66	12	
32	31	AL	6F	101,86	100,00	106,0	65	21	31	10
40	AL	6F	101,86	100,00	106,0	65	30	40	10	
47	AL	6F	101,86	100,00	106,0	65	37	47	12	
66	AL	6F	101,86	100,00	106,0	65	56	66	12	
36	31	AL	6F	114,59	112,75	119,0	70	21	31	10
40	AL	6F	114,59	112,75	119,0	70	30	40	10	
47	AL	6F	114,59	112,75	119,0	70	37	47	16	
66	AL	6F	114,59	112,75	119,0	70	56	66	16	
40	31	AL	6F	127,32	125,45	131,0	80	21	31	10
40	AL	6F	127,32	125,45	131,0	80	30	40	10	
47	AL	6F	127,32	125,45	131,0	80	37	47	16	
66	AL	6F	127,32	125,45	131,0	80	56	66	16	
44	31	AL	6	140,05	138,20	-	88	21	31	10
40	AL	6	140,05	138,20	-	88	30	40	10	
47	AL	6	140,05	138,20	-	88	37	47	16	
66	AL	6	140,05	138,20	-	88	56	66	16	
48	31	AL	6	152,78	150,95	-	95	21	31	16
40	AL	6	152,78	150,95	-	95	30	40	16	
47	AL	6	152,78	150,95	-	95	37	47	16	
66	AL	6	152,78	150,95	-	95	56	66	16	
60	31	AL	6	190,98	189,10	-	110	21	31	16
40	AL	6	190,98	189,10	-	110	30	40	16	
47	AL	6	190,98	189,10	-	110	37	47	16	
66	AL	6	190,98	189,10	-	110	56	66	16	

OSUBENÉ

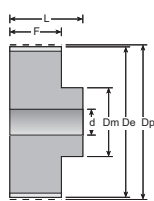

TYP 6

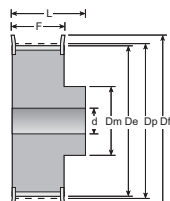

TYP 6F

Vzor označení

53 - AT20 - 18

kód
šířky

počet
zubů

Kód šířky řemenu

53 = 32 mm

71 = 50 mm

123 = 100 mm

AT20										
Počet zubů	Kód šířky řemenu	Materiál	Typ	D _p	D _e	D _f	D _m	F	L	d
18	53	AL	6F	114,59	111,75	120,0				
	71	AL	6F	114,59	111,75	120,0				
	123	AL	6F	114,59	111,75	120,0				
20	53	AL	6F	127,32	124,50	138,0				
	71	AL	6F	127,32	124,50	138,0				
	123	AL	6F	127,32	124,50	138,0				
22	53	AL	6F	140,06	137,20	146,0				
	71	AL	6F	140,06	137,20	146,0				
	123	AL	6F	140,06	137,20	146,0				
24	53	AL	6F	152,79	149,95	158,0				
	71	AL	6F	152,79	149,95	158,0				
	123	AL	6F	152,79	149,95	158,0				
25	53	AL	6F	159,15	156,30	168,0				
	71	AL	6F	159,15	156,30	168,0				
	123	AL	6F	159,15	156,30	168,0				
30	53	AL	6F	190,99	188,15	200,0				
	71	AL	6F	190,99	188,15	200,0				
	123	AL	6F	190,99	188,15	200,0				

Počet zubů	Kód šířky řemenu	Materiál	Typ	D _p	D _e	D _f	D _m	F	L	d
32	53	AL	6	203,72	200,85	-				
	71	AL	6	203,72	200,85	-				
	123	AL	6	203,72	200,85	-				
36	53	AL	6	229,18	226,35	-				
	71	AL	6	229,18	226,35	-				
	123	AL	6	229,18	226,35	-				
40	53	AL	6	254,65	251,80	-				
	71	AL	6	254,65	251,80	-				
	123	AL	6	254,65	251,80	-				
48	53	AL	6	305,58	302,70	-				
	71	AL	6	305,58	302,70	-				
	123	AL	6	305,58	302,70	-				
60	53	AL	6	381,97	379,10	-				
	71	AL	6	381,97	379,10	-				
	123	AL	6	381,97	379,10	-				
72	53	AL	6	458,37	455,50	-				
	71	AL	6	458,37	455,50	-				
	123	AL	6	458,37	455,50	-				

Všechny řemenice AT20, včetně rozměrů zde neuvedených, dodáváme pouze na poptávku.

OSUBENÉ ŘEMENICE HTD

S PLNÝM PŘEDVRTANÝM NÁBOJEM

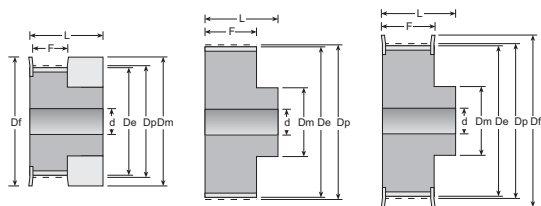

TYP 1F

TYP 6

TYP 6F

Vzor označení
10 - 3M - 9

HTD 3M										
Počet zubů	Pro šířku řemenu	Materiál	Typ	Dp	De	Df	Dm	F	L	d
10	9	AL	1F	9,55	8,79	13,0	13	10,2	17,5	-
15	AL	1F	9,55	8,79	13,0	13	17	26	-	-
12	9	AL	1F	11,46	10,70	15,0	15	10,2	17,5	-
15	AL	1F	11,46	10,70	15,0	15	17	26	-	-
14	9	AL	1F	13,37	12,61	16,0	16	10,2	17,5	-
15	AL	1F	13,37	12,61	16,0	16	17	26	-	-
15	9	AL	1F	14,32	13,56	17,5	17,5	10,2	17,5	-
15	AL	1F	14,32	13,56	17,5	17,5	17	26	-	-
16	9	AL	6F	15,28	14,52	18,0	9,5	12,8	20,6	4
15	AL	6F	15,28	14,52	18,0	9,5	19,5	26	4	4
18	9	AL	6F	17,19	16,43	19,5	10	12,8	20,6	6
15	AL	6F	17,19	16,43	19,5	10	19,5	26	6	6
20	9	AL	6F	19,10	18,34	23,0	12	12,8	20,6	6
15	AL	6F	19,10	18,34	23,0	12	19,5	26	6	6
21	9	AL	6F	20,05	19,29	25,0	13	12,8	20,6	6
15	AL	6F	20,05	19,29	25,0	13	19,5	26	6	6
22	9	AL	6F	21,01	20,25	25,0	13	12,8	20,6	6
15	AL	6F	21,01	20,25	25,0	13	19,5	26	6	6
24	9	AL	6F	22,92	22,16	25,0	13	12,8	20,6	6
15	AL	6F	22,92	22,16	25,0	13	19,5	26	6	6

Počet zubů	Pro šířku řemenu	Materiál	Typ	Dp	De	Df	Dm	F	L	d
26	9	AL	6F	24,83	24,07	28,0	16	12,8	20,6	6
15	AL	6F	24,83	24,07	28,0	16	19,5	26	6	6
28	9	AL	6F	26,74	25,98	32,0	18	12,8	20,6	6
15	AL	6F	26,74	25,98	32,0	18	19,5	26	6	6
30	9	AL	6F	28,65	27,89	32,0	19	12,8	20,6	6
15	AL	6F	28,65	27,89	32,0	19	19,5	26	6	6
32	9	AL	6F	30,56	29,80	36,0	22	12,8	20,6	6
15	AL	6F	30,56	29,80	36,0	22	19,5	26	6	6
36	9	AL	6F	34,38	33,62	38,0	26	13,4	22,2	6
15	AL	6F	34,38	33,62	38,0	26	20	30	6	6
40	9	AL	6F	38,20	37,44	42,0	28	13,4	22,2	6
15	AL	6F	38,20	37,44	42,0	28	20	30	6	6
44	9	AL	6F	42,02	41,26	48,0	33	13,4	22,2	6
15	AL	6F	42,02	41,26	48,0	33	20	30	6	6
48	9	AL	6	45,84	45,08	-	33	13,4	22,2	8
15	AL	6	45,84	45,08	-	33	20	30	8	8
60	9	AL	6	57,30	56,54	-	33	13,4	22,2	8
15	AL	6	57,30	56,54	-	33	20	30	8	8
72	9	AL	6	68,75	67,99	-	33	13,4	22,2	8
15	AL	6	68,75	67,99	-	33	20	30	8	8

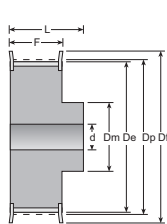

TYP 6F

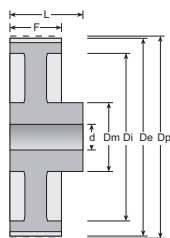

TYP 6W

Vzor označení
12 - 5M - 9

HTD 5M										
Počet zubů	Pro šířku řemenu	Materiál	Typ	Dp	De	Df	Dm	F	L	d
12	9	ST	6F	19,10	17,96	23,0	13	14,5	20	4
15	ST	6F	19,10	17,96	25,0	13	20,5	26	-	-
25	ST	6F	19,10	17,96	25,0	13	30,5	36	-	-
14	9	ST	6F	22,28	21,14	25,0	13	14,5	27	6
15	ST	6F	22,28	21,14	25,0	13	20,5	26	6	6
25	ST	6F	22,28	21,14	25,0	13	30,5	36	6	6
15	9	ST	6F	23,87	22,73	28,0	16	14,5	20	6
15	ST	6F	23,87	22,73	28,0	16	20,5	26	6	6
25	ST	6F	23,87	22,73	28,0	16	30,5	36	6	6
16	9	ST	6F	25,46	24,32	28,0	16	14,5	20	6
15	ST	6F	25,46	24,32	28,0	16	20,5	26	6	6
25	ST	6F	25,46	24,32	28,0	16	30,5	36	6	6
18	9	ST	6F	28,65	27,51	32,0	19	14,5	20	6
15	ST	6F	28,65	27,51	32,0	19	20,5	26	6	6
25	ST	6F	28,65	27,51	32,0	19	30,5	36	6	6
20	9	ST	6F	31,83	30,69	36,0	23	14,5	22,5	6
15	ST	6F	31,83	30,69	36,0	23	20,5	26	6	6
25	ST	6F	31,83	30,69	36,0	23	30,5	36	6	6
21	9	ST	6F	33,42	32,28	38,0	24	14,5	22,5	6
15	ST	6F	33,42	32,28	38,0	24	20,5	26	6	6
25	ST	6F	33,42	32,28	38,0	24	30,5	36	6	6
22	9	ST	6F	35,01	33,87	38,0	25,5	14,5	22,5	6
15	ST	6F	35,01	33,87	38,0	25,5	20,5	26	6	6
25	ST	6F	35,01	33,87	38,0	25,5	30,5	38	6	6
24	9	ST	6F	38,20	37,06	42,0	27	14,5	22,5	6
15	ST	6F	38,20	37,06	42,0	27	20,5	28	6	6
25	ST	6F	38,20	37,06	42,0	27	30,5	38	6	6
26	9	ST	6F	41,38	40,24	44,0	30	14,5	22,5	6
15	ST	6F	41,38	40,24	44,0	30	20,5	28	6	6
5	ST	6F	41,38	40,24	44,0	30	30,5	38	6	6

Počet zubů	Pro šířku řemenu	Materiál	Typ	Dp	De	Df	Dm	F	L	d
28	9	ST	6F	44,56	43,42	48,0	30,5	14,5	22,5	6
15	ST	6F	44,56	43,42	48,0	30,5	20,5	28	6	6
25	ST	6F	44,56	43,42	48,0	30,5	30,5	38	6	6
30	9	ST	6F	47,75	46,60	51,0	35	14,5	22,5	6
15	ST	6F	47,75	46,60	51,0	35	20,5	28	6	6
25	ST	6F	47,75	46,60	51,0	35	30,5	38	6	6
32	9	ST	6F	50,93	49,79	54,0	38	14,5	22,5	8
15	ST	6F	50,93	49,79	54,0	38	20,5	28	8	8
25	ST	6F	50,93	49,79	54,0	38	30,5	38	8	8
36	9	ST	6F	57,30	56,16	60,0	38	14,5	22,5	8
15	ST	6F	57,30	56,16	60,0	38	20,5	28	8	8
25	ST	6F	57,30	56,16	60,0	38	30,5	38	8	8
40	9	ST	6F	63,66	62,52	71,0	38	14,5	22,5	8
15	ST	6F	63,66	62,52	71,0	38	20,5	28	8	8
25	ST	6F	63,66	62,52	71,0	38	30,5	38	8	8
44	9	AL	6W	70,03	68,89	-	38	14,5	25,5	8
15	AL	6W	70,03	68,89	-	38	20,5	30	8	8
25	AL	6	70,03	68,89	-	38	30,5	40	8	8
48	9	AL	6W	76,39	75,25	-	45	14,5	25,5	8
15	AL	6W	76,39	75,25	-	38	20,5	30	8	8
25	AL	6W	76,39	75,25	-	38	30,5	40	8	8
60	9	AL	6W	95,49	94,35	-	45	14,5	25,5	8
15	AL	6W	95,49	94,35	-	50	20,5	30	8	8
25	AL	6W	95,49	94,35	-	50	30,5	40	8	8
72	9	AL	6W	114,59	113,45	-	45	14,5	25,5	8
15	AL	6W	114,59	113,45	-	50	20,5	30	8	8
25	AL	6W	114,59	113,45	-	50	30,5	40	8	8

OSUZBENÉ ŘEMENICE HTD

S PLNÝM PŘEDVRTANÝM NÁBOJEM

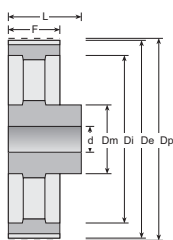

TYP 6A

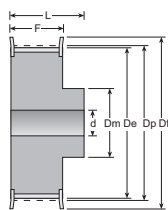

TYP 6F

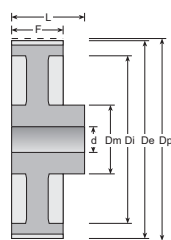

TYP 6W

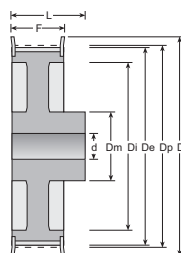

TYP 6WF

Vzor označení
22 - 8M - 20

HTD 8M

Počet zubů	Pro šířku řemenu	Materiál	Typ	Dp	De	Df	Dm	F	L	d
22	20	ST	6F	56,02	54,65	60,0	43	28	38	12
	30	ST	6F	56,02	54,65	60,0	43	38	48	12
	50	ST	6F	56,02	54,65	60,0	43	60	70	-
	85	ST	6F	56,02	54,65	60,0	43	95	105	-
24	20	ST	6F	61,12	59,75	66,0	45	28	38	12
	30	ST	6F	61,12	59,75	66,0	45	38	48	12
	50	ST	6F	61,12	59,75	66,0	45	60	70	-
	85	ST	6F	61,12	59,75	66,0	45	95	105	-
26	20	ST	6F	66,21	64,84	71,0	50	28	38	12
	30	ST	6F	66,21	64,84	71,0	50	38	48	12
	50	ST	6F	66,21	64,84	71,0	50	60	70	-
	85	ST	6F	66,21	64,84	71,0	50	95	105	-
28	20	ST	6F	71,30	70,08	75,0	50	28	38	15
	30	ST	6F	71,30	70,08	75,0	50	38	48	15
	50	ST	6F	71,30	70,08	75,0	50	60	70	-
	85	ST	6F	71,30	70,08	75,0	50	95	105	-
30	20	ST	6F	76,39	75,13	83,0	55	28	38	15
	30	ST	6F	76,39	75,13	83,0	55	38	48	15
	50	ST	6F	76,39	75,13	83,0	55	60	70	-
	85	ST	6F	76,39	75,13	83,0	55	95	105	-
32	20	ST	6F	81,49	80,16	87,0	60	28	38	15
	30	ST	6F	81,49	80,16	87,0	60	38	48	15
	50	ST	6F	81,49	80,16	87,0	60	60	70	-
	85	ST	6F	81,49	80,16	87,0	60	95	105	-
34	20	ST	6F	86,58	85,22	91,0	70	28	38	15
	30	ST	6F	86,58	85,22	91,0	70	38	48	15
	50	ST	6F	86,58	85,22	91,0	70	60	70	-
	85	ST	6F	86,58	85,22	91,0	70	95	105	-
36	20	ST	6F	91,67	90,30	98,5	70	28	38	15
	30	ST	6F	91,67	90,30	98,5	70	38	48	15
	50	ST	6F	91,67	90,30	98,5	70	60	70	-
	85	ST	6F	91,67	90,30	98,5	70	95	105	-
38	20	ST	6F	96,77	95,39	103,0	75	28	38	15
	30	ST	6F	96,77	95,39	103,0	75	38	48	15
	50	ST	6F	96,77	95,39	103,0	75	60	70	-
	85	ST	6F	96,77	95,39	103,0	75	95	105	-
40	20	ST	6F	101,86	100,49	106,0	75	28	38	15
	30	ST	6F	101,86	100,49	106,0	75	38	48	15
	50	ST	6F	101,86	100,49	106,0	75	60	70	-
	85	ST	6F	101,86	100,49	106,0	75	95	105	-
44	20	ST	6F	112,05	110,67	119,0	75	28	38	15
	30	ST	6F	112,05	110,67	119,0	75	38	48	15
	50	ST	6F	112,05	110,67	119,0	75	60	70	-
	85	ST	6F	112,05	110,67	119,0	75	95	105	-

* Na poptávku

Počet zubů	Pro šířku řemenu	Materiál	Typ	Dp	De	Df	Dm	F	L	d
48	20	ST	6F	122,23	120,86	127,0	75	28	38	15
	30	ST	6F	122,23	120,86	127,0	75	38	48	15
	50	ST	6F	122,23	120,86	127,0	80	60	70	-
	85	ST	6F	122,23	120,86	127,0	80	95	105	-
56	20	ST	6WF	142,60	141,23	148,0	80	28	38	15
	30	ST	6WF	142,60	141,23	148,0	90	38	48	15
	50	ST	10WF	142,60	141,23	148,0	90	60	60	18
	85	ST	6F	142,60	141,23	148,0	80	95	105	20
64	20	ST	6WF	162,97	161,60	168,0	80	28	38	15
	30	ST	6WF	162,97	161,60	168,0	90	38	48	15
	50	ST	10WF	162,97	161,60	168,0	100	60	60	18
	85	ST	10WF	162,97	161,60	168,0	100	95	95	20
72	20	ST	6WF	183,35	181,97	192,0	80	28	38	15
	30	ST	6WF	183,35	181,97	192,0	95	38	48	15
	50	ST	10WF	183,35	181,97	192,0	100	60	60	18
	85	ST	10WF	183,35	181,97	192,0	110	95	95	20
80	20	GG	6W	203,72	202,35	-	90	28	38	15
	30	GG	6W	203,72	202,35	-	100	38	48	15
	50	GG	10W	203,72	202,35	-	110	60	60	18
	85	GG	10A	203,72	202,35	-	110	95	95	20
90	20	GG	6W	229,18	227,81	-	90	28	38	15
	30	GG	6W	229,18	227,81	-	100	38	48	15
	50	GG	10W	229,18	227,81	-	110	60	60	18
	85	GG	10A	229,18	227,81	-	110	95	95	20
112	20*	GG	6A	285,21	283,83	-	90	28	38	18
	30	GG	6A	285,21	283,83	-	100	38	48	18
	50	GG	10A	285,21	283,83	-	110	60	60	18
	85	GG	10A	285,21	283,83	-	110	95	95	24
144	20*	GG	6A	366,69	365,32	-	90	28	38	20
	30	GG	6A	366,69	365,32	-	100	38	48	20
	50	GG	10A	366,69	365,32	-	110	60	60	20
	85	GG	10A	366,69	365,32	-	120	95	95	24
168	20*	GG	6A	427,81	426,44	-	100	28	38	20
	30	GG	6A	427,81	426,44	-	100	38	48	20
	50	GG	10A	427,81	426,44	-	120	60	60	20
	85	GG	10A	427,81	426,44	-	120	95	95	24
192	20*	GG	6A	488,92	487,55	-	100	28	38	20
	30	GG	6A	488,92	487,55	-	100	38	48	20
	50	GG	10A	488,92	487,55	-	130	60	60	20
	85	GG	10A	488,92	487,55	-	130	95	95	24

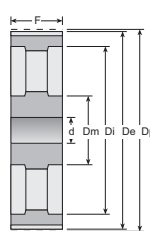

TYP 10A

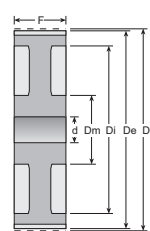

TYP 10W

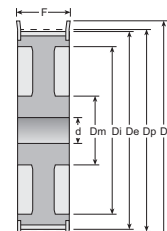

TYP 10WF

OZUBENÉ ŘEMENICE HTD

S PLNÝM PŘEDVRTANÝM NÁBOJEM

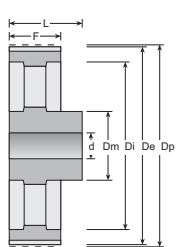

TYP 6A

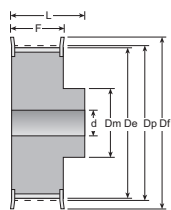

TYP 6F

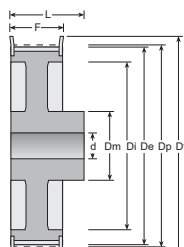

TYP 6WF

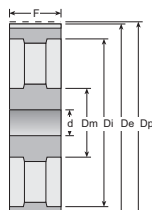

TYP 10A

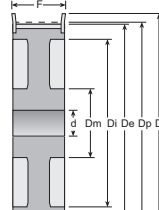

TYP 10WF

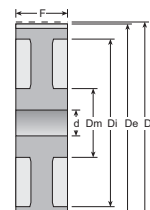

TYP 10W

Vzor označení
48 - 14M - 85

HTD 14M										
Počet zubů	Pro šířku řemenu	Materiál	Typ	Dp	De	Df	Dm	F	L	d
28	40	GG	6F	124,78	122,12	127,0	100	54	69	24
	55	GG	6F	124,78	122,12	127,0	100	70	85	24
	85	GG	6F	124,78	122,12	127,0	100	102	117	-
	115	GG	6F	124,78	122,12	127,0	100	133	148	-
	170	GG	6F	124,78	122,12	127,0	100	187	202	-
29*	40	GG	6F	129,23	126,57	138,0	100	54	69	24
	55	GG	6F	129,23	126,57	138,0	100	70	85	24
	85	GG	6F	129,23	126,57	138,0	100	102	117	-
	115	GG	6F	129,23	126,57	138,0	100	133	148	-
	170	GG	6F	129,23	126,57	138,0	100	187	202	-
30	40	GG	6F	133,69	130,99	138,0	100	54	69	24
	55	GG	6F	133,69	130,99	138,0	100	70	85	24
	85	GG	6F	133,69	130,99	138,0	100	102	117	-
	115	GG	6F	133,69	130,99	138,0	100	133	148	-
	170	GG	6F	133,69	130,99	138,0	100	187	202	-
32	40	GG	6F	142,60	139,88	154,0	100	54	69	24
	55	GG	6F	142,60	139,88	154,0	100	70	85	24
	85	GG	6F	142,60	139,88	154,0	100	102	117	-
	115	GG	6F	142,60	139,88	154,0	100	133	148	-
	170	GG	6F	142,60	139,88	154,0	100	187	202	-
34	40	GG	6F	151,52	148,79	160,0	100	54	69	24
	55	GG	6F	151,52	148,79	160,0	100	70	85	24
	85	GG	6F	151,52	148,79	160,0	100	102	117	-
	115	GG	6F	151,52	148,79	160,0	100	133	148	-
	170	GG	6F	151,52	148,79	160,0	100	187	202	-
36	40	GG	6F	160,43	157,68	168,0	100	54	69	24
	55	GG	6F	160,43	157,68	168,0	100	70	85	24
	85	GG	6F	160,43	157,68	168,0	100	102	117	-
	115	GG	6F	160,43	157,68	168,0	120	133	148	-
	170	GG	6F	160,43	157,68	168,0	120	187	202	-
38	40	GG	6F	169,34	166,60	183,0	120	54	69	24
	55	GG	6F	169,34	166,60	183,0	120	70	85	24
	85	GG	6F	169,34	166,60	183,0	120	102	117	-
	115	GG	6F	169,34	166,60	183,0	120	133	148	-
	170	GG	6F	169,34	166,60	183,0	135	187	202	-
40	40	GG	6F	178,25	175,49	188,0	120	54	69	24
	55	GG	6F	178,25	175,49	188,0	120	70	85	32
	85	GG	6F	178,25	175,49	188,0	135	102	117	-
	115	GG	6F	178,25	175,49	188,0	135	133	148	-
	170	GG	6F	178,25	175,49	188,0	140	187	202	-
44	40	GG	6F	196,08	193,28	211,0	120	54	69	24
	55	GG	6F	196,08	193,28	211,0	120	70	85	24
	85	GG	6F	196,08	193,28	211,0	135	102	117	-
	115	GG	6F	196,08	193,28	211,0	140	133	148	-
	170*	GG	6F	196,08	193,28	211,0	160	187	202	-
48	40	GG	6WF	213,90	211,11	226,0	135	54	69	24
	55	GG	10WF	213,90	211,11	226,0	135	70	70	24
	85	GG	6F	213,90	211,11	226,0	150	102	117	-
	115	GG	6F	213,90	211,11	226,0	150	133	148	-
	170*	GG	6F	213,90	211,11	226,0	160	187	202	-

* Na poptávku

Počet zubů	Pro šířku řemenu	Materiál	Typ	Dp	De	Df	Dm	F	L	d
56	40	GG	6WF	249,55	246,76	256,0	135	54	69	28
	55	GG	10WF	249,55	246,76	256,0	135	70	70	28
	85	GG	10WF	249,55	246,76	256,0	150	102	102	32
	115	GG	6F	249,55	246,76	256,0	150	133	148	-
	170*	GG	6F	249,55	246,76	256,0	160	187	202	-
64	40	GG	6WF	285,21	282,41	296,0	135	54	69	28
	55	GG	10WF	285,21	282,41	296,0	135	70	70	28
	85	GG	10WF	285,21	282,41	296,0	150	102	102	32
	115	GG	10WF	285,21	282,41	296,0	150	133	133	32
	170*	GG	6F	285,21	282,41	296,0	180	187	187	-
72	40	GG	6A	320,86	318,06	-	135	54	69	28
	55	GG	10A	320,86	318,06	-	135	70	70	28
	85	GG	10A	320,86	318,06	-	150	102	102	32
	115	GG	10A	320,86	318,06	-	150	133	133	32
	170*	GG	10W	320,86	318,06	-	150	187	187	32
80	40	GG	6A	356,51	353,71	-	135	54	69	28
	55	GG	10A	356,51	353,71	-	135	70	70	28
	85	GG	10A	356,51	353,71	-	150	102	102	32
	115	GG	10A	356,51	353,71	-	150	133	133	32
	170	GG	10W	356,51	353,71	-	180	187	187	32
90	40	GG	6A	401,07	398,28	-	135	54	69	28
	55	GG	10A	401,07	398,28	-	135	70	70	28
	85	GG	10A	401,07	398,28	-	150	102	102	32
	115	GG	10A	401,07	398,28	-	150	133	133	32
	170	GG	10A	401,07	398,28	-	180	187	187	38
112	40	GG	6A	499,11	496,32	-	135	54	69	28
	55	GG	10A	499,11	496,32	-	135	70	70	28
	85	GG	10A	499,11	496,32	-	150	102	102	32
	115	GG	10A	499,11	496,32	-	150	133	133	32
	170	GG	10A	499,11	496,32	-	200	187	187	38
144	40*	GG	6A	641,71	638,92	-	135	54	69	28
	55	GG	10A	641,71	638,92	-	135	70	70	28
	85	GG	10A	641,71	638,92	-	150	102	102	32
	115	GG	10A	641,71	638,92	-	165	133	133	32
	170	GG	10A	641,71	638,92	-	220	187	187	38
168	40*	GG	6A	748,66	745,87	-	135	54	69	28
	55	GG	10A	748,66	745,87	-	135	70	70	28
	85	GG	10A	748,66	745,87	-	150	102	102	32
	115	GG	10A	748,66	745,87	-	165	133	133	32
	170	GG	10A	748,66	745,87	-	220	187	187	38
192	40*	GG	6A	855,62	852,82	-	135	54	69	28
	55	GG	10A	855,62	852,82	-	135	70	70	28
	85	GG	10A	855,62	852,82	-	150	102	102	32
	115	GG	10A	855,62	852,82	-	165	133	133	32
	170*	GG	10A	855,62	852,82	-	220	187	187	38
216*	40	GG	6A	962,57	959,76	-	150	54	69	28
	55	GG	10A	962,57	959,76	-	150	70	70	28
	85	GG	10A	962,57	959,76	-	165	102	102	32
	115	GG	10A	962,57	959,76	-	165	133	133	32
	170	GG	10A	962,57	959,76	-	220	187	187	38

OSUBENÉ ŘEMENICE HTD

PRO KUŽELOVÉ POUZDRO TB

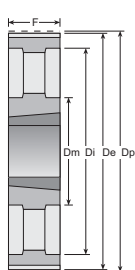

TYP 3A

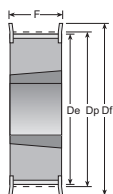

TYP 3F

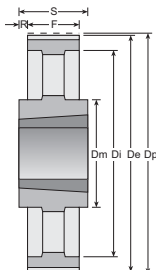

TYP 7A

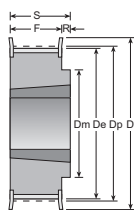

TYP 8F

Vzor označení

34 - 5M - 15 TB 1008

HTD 5M (TB)

Počet zubů	Pro šířku řemenu	Číslo TB pouzdra	Material	Typ	Dp	De	Df	Dm	F	S
34	15	1008	ST	3F	54,11	52,97	57	43	20,5	22
36	15	1108	ST	3F	57,30	56,16	60	44	20,5	22
38	15	1108	ST	3F	69,48	59,34	66	48	20,5	22
40	15	1108	ST	3F	63,66	62,52	71	52	20,5	22
44	15	1108	ST	3F	70,03	68,89	75	54	20,5	22
48	15	1210	ST	8F	76,39	75,25	83	64	20,5	25
56	15	1210	ST	8F	89,13	87,99	93	70	20,5	25

Počet zubů	Pro šířku řemenu	Číslo TB pouzdra	Material	Typ	Dp	De	Df	Dm	F	S
64	15	1210	ST	8F	101,72	100,72	106	80	20,5	25
72	15	1610	ST	3A	114,59	113,45	-	92	20,5	25
80	15	1610	ST	3A	127,32	126,18	-	92	20,5	25
90	15	1610	ST	3A	143,24	142,10	-	92	20,5	25
112	15	2012	ST	3A	178,25	177,11	-	110	20,5	32
136	15	2012	ST	7A	216,45	215,31	-	110	20,5	32
150	15	2012	GG	7A	238,73	237,59	-	106	20,5	32

OZUBENÉ ŘEMENICE HTD

PRO KUŽELOVÉ POUZDRO TB

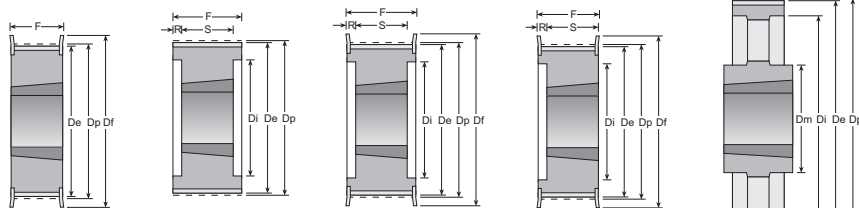

TYP 3F

TYP 4

TYP 4F

TYP 5F

TYP 7A

Vzor označení
64 - 8M - 30 TB 2517

HTD 8M (TB)

Počet zubů	Pro šířku řemenu	Číslo TB pouzdra	Material	Typ	Dp	De	Df	Dm	F	S
22	20	1008	ST	5F	56,02	54,65	60	-	28	22
30	30	1008	ST	5F	56,02	54,65	60	-	38	22
24	20	1108	ST	5F	61,12	59,75	66	-	28	22
30	30	1108	ST	5F	61,12	59,75	66	-	38	22
26	20	1108	ST	5F	66,21	64,84	71	-	28	22
30	30	1108	ST	5F	66,21	64,84	71	-	38	22
28	20	1108	ST	5F	71,30	70,08	75	-	28	22
30	30	1210	ST	5F	71,30	70,08	75	-	38	25
50	50	1210	ST	5F	71,30	70,08	75	-	60	25
30	20	1108	ST	5F	76,39	75,13	83	-	28	22
30	30	1615	ST	3F	76,39	75,13	83	-	38	38
50	50	1615	ST	5F	76,39	75,13	83	-	60	38
32	20	1610	ST	5F	81,49	80,16	87	-	28	25
30	30	1615	ST	3F	81,49	80,16	87	-	38	38
50	50	1615	ST	5F	81,49	80,16	87	-	60	38
34	20	1610	ST	5F	86,58	85,22	91	-	28	25
30	30	1615	ST	3F	86,58	85,22	91	-	38	38
50	50	1615	ST	5F	86,58	85,22	91	-	60	38
85	85	1615	ST	4F	86,58	85,22	91	-	95	38
36	20	1610	ST	5F	91,67	90,30	97	-	28	25
30	30	1615	ST	3F	91,67	90,30	97	-	38	38
50	50	1615	ST	4F	91,67	90,30	97	-	60	38
85	85	1615	ST	4F	91,67	90,30	97	-	95	38
38	20	1610	ST	5F	96,77	95,39	103	-	28	25
30	30	1615	ST	3F	96,77	95,39	103	-	38	38
50	50	1615	ST	3F	96,77	95,39	103	-	60	38
85	85	1615	ST	4F	96,77	95,39	103	-	95	38
40	20	1610	ST	5F	101,86	100,49	106	-	28	25
30	30	1615	ST	3F	101,86	100,49	106	-	38	38
50	50	2012	ST	4F	101,86	100,49	106	-	60	32
85	85	2012	ST	4F	101,86	100,49	106	-	95	32
44	20	2012	ST	8F	112,05	110,67	119	92	28	32
30	30	2012	ST	5F	112,05	110,67	119	-	38	32
50	50	2012	ST	4F	112,05	110,67	119	-	60	32
85	85	2012	ST	4F	112,05	110,67	119	-	95	32
48	20	2012	ST	8F	122,23	120,86	127	96	28	32

Počet zubů	Pro šířku řemenu	Číslo TB pouzdra	Material	Typ	Dp	De	Df	Dm	F	S
30	2012	2012	ST	5F	122,23	120,86	127	-	38	32
50	2012	2012	ST	4F	122,23	120,86	127	-	60	32
85	2517	2517	ST	4F	122,23	120,86	127	-	95	45
56	20	2012	ST	8F	142,60	141,23	148	110	28	32
30	2012	2012	ST	5F	142,60	141,23	148	-	38	32
50	2517	2517	ST	4F	142,60	141,23	148	-	60	45
85	2517	2517	ST	4F	142,60	141,23	148	-	95	45
64	20	2012	ST	8WF	162,97	161,60	168	110	28	32
30	2517	2517	ST	5F	162,97	161,60	168	125	38	45
50	2517	2517	ST	4F	162,97	161,60	168	-	60	45
85	2517	2517	ST	4F	162,97	161,60	168	-	95	45
72	20	2012	ST	8WF	183,35	181,97	192	110	28	32
30	2517	2517	ST	8WF	183,35	181,97	192	125	38	45
50	2517	2517	ST	9WF	183,35	181,97	192	125	60	45
85	3020	3020	ST	4F	183,35	181,97	192	-	95	51
80	20	2012	GG	8W	203,72	202,35	-	110	28	32
30	2517	2517	GG	8W	203,72	202,35	-	125	38	45
50	3020	3020	GG	4	203,72	202,35	-	-	60	51
85	3020	3020	GG	4	203,72	202,35	-	-	95	51
90	20	2012	GG	8W	229,18	227,81	-	110	28	32
30	2517	2517	GG	8W	229,18	227,81	-	125	38	45
50	3020	3020	GG	9W	229,18	227,81	-	170	60	51
85	3020	3020	GG	4	229,18	227,81	-	170	95	51
112	20	2517	GG	8W	285,21	283,83	-	125	28	45
30	2517	2517	GG	8W	285,21	283,83	-	125	38	45
50	3020	3020	GG	9W	285,21	283,83	-	170	60	51
85	3020	3020	GG	9W	285,21	283,83	-	170	95	51
144	20	2517	GG	7A	366,69	365,32	-	125	28	45
30	2517	2517	GG	8A	366,69	365,32	-	125	38	45
50	3020	3020	GG	9A	366,69	365,32	-	170	60	51
85	3525	3525	GG	9W	366,69	365,32	-	190	95	65
168	50	3525	GG	7A	427,81	426,44	-	190	60	65
85	3525	3525	GG	9A	427,81	426,44	-	190	95	65
192	50	3525	GG	7A	488,92	487,55	-	190	60	65
85	3525	3525	GG	9A	488,92	487,55	-	190	95	65

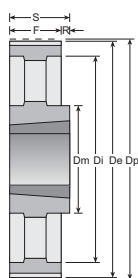

TYP 8A

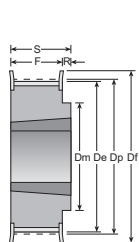

TYP 8F

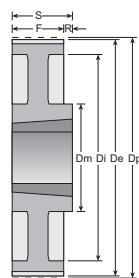

TYP 8W

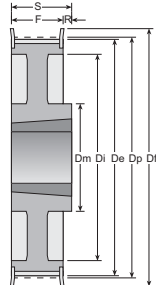

TYP 8WF

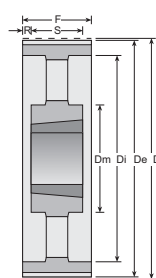

TYP 9A

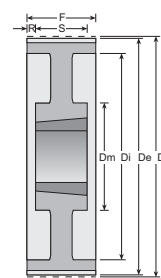

TYP 9W

OSUZBENÉ ŘEMENICE HTD

PRO KUŽELOVÉ POUZDRO TB

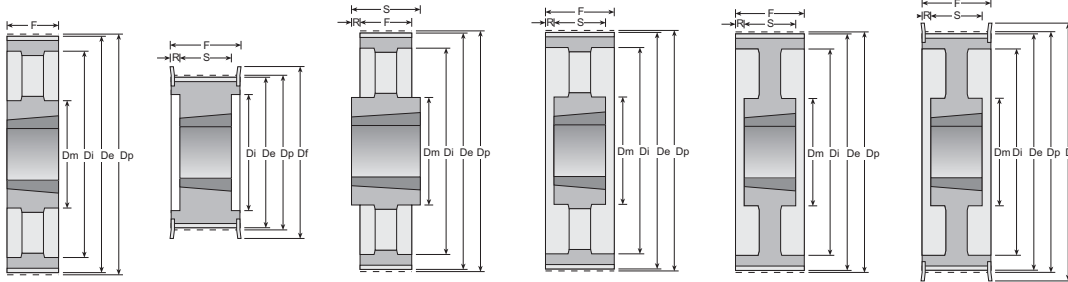

TYP 3A

TYP 4F

TYP 7A

TYP 9A

TYP 9W

TYP 9WF

Vzor označení

72 - 14M - 85 TB 3525

HTD 14M (TB)

Počet zubů	Pro šířku řemenu	Číslo TB pouzdra	Material	Typ	Dp	De	Df	Dm	F	S
28	40	2012	ST	4F	124,78	122,12	127	-	54	32
	55	2012	ST	4F	124,78	122,12	127	-	70	32
	85	2517	ST	4F	124,78	122,12	127	-	102	45
	115	2517	ST	4F	124,78	122,12	127	-	133	45
29	40*	2012	ST	4F	129,3	126,57	138	-	54	32
	55*	2012	ST	4F	129,3	126,57	138	-	70	32
	85*	2517	ST	4F	129,3	126,57	138	-	102	45
	115*	2517	ST	4F	129,3	126,57	138	-	133	45
30	40	2012	ST	4F	133,69	130,99	138	-	54	32
	55	2517	ST	4F	133,69	130,99	138	-	70	45
	85	2517	ST	4F	133,69	130,99	138	-	102	45
	115	2517	ST	4F	133,69	130,99	138	-	133	45
32	40	2012	ST	4F	142,60	139,88	154	-	54	32
	55	2517	ST	4F	142,60	139,88	154	-	70	45
	85	2517	ST	4F	142,60	139,88	154	-	102	45
	115	2517	ST	4F	142,60	139,88	154	-	133	45
34	40	2517	ST	4F	151,52	148,79	160	-	54	45
	55	2517	ST	4F	151,52	148,79	160	-	70	45
	85	2517	ST	4F	151,52	148,79	160	-	102	45
	115	2517	ST	4F	151,52	148,79	160	-	133	45
36	40	2517	ST	4F	160,43	157,68	168	-	54	45
	55	2517	ST	4F	160,43	157,68	168	-	70	45
	85	3020	ST	4F	160,43	157,68	168	-	102	51
	115	3020	ST	4F	160,43	157,68	168	-	133	51
38	40	2517	ST	4F	169,34	166,60	183	-	54	45
	55	2517	ST	4F	169,34	166,60	183	-	70	45
	85	3020	ST	4F	169,34	166,60	183	-	102	51
	115	3020	ST	4F	169,34	166,60	183	-	133	51
40	40	2517	ST	4F	178,25	175,49	188	-	54	45
	55	2517	ST	4F	178,25	175,49	188	-	70	45
	85	3020	ST	4F	178,25	175,49	188	-	102	51
	115	3020	ST	4F	178,25	175,49	188	-	133	51
44	40	3020	ST	4F	196,08	193,28	211	-	54	51
	55	3020	ST	4F	196,08	193,28	211	-	70	51
	85	3020	ST	4F	196,08	193,28	211	-	102	76
	115	3030	ST	4F	196,08	193,28	211	-	133	76
48	40	3020	ST	4F	213,90	211,11	226	-	54	51
	55	3020	ST	4F	213,90	211,11	226	-	70	51
	85	3020	ST	4F	213,90	211,11	226	-	102	76
	115	3030	ST	4F	213,90	211,11	226	-	133	76
56	40	3020	ST	4F	249,55	246,76	256	170	54	51
	55	3020	ST	4F	249,55	246,76	256	170	70	51
	85	3525	ST	4F	249,55	246,76	256	190	102	65
	115	3535	ST	4F	249,55	246,76	256	-	133	89
170	3535	ST	4F	249,55	246,76	256	-	187	89	

* Na poptávku

Počet zubů	Pro šířku řemenu	Číslo TB pouzdra	Material	Typ	Dp	De	Df	Dm	F	S	
64	40*	3020	GG	9WF	285,21	282,41	296	170	54	51	
	55	3020	GG	9WF	285,21	282,41	296	170	70	51	
	85	3525	GG	9WF	285,21	282,41	296	190	102	65	
	115	3535	GG	9WF	285,21	282,41	296	190	133	89	
170*	4040	GG	4F	285,21	282,41	296	-	187	102		
	72	40	3020	GG	9W	320,86	318,06	-	170	54	51
		55	3020	GG	9W	320,86	318,06	-	170	70	51
		85	3525	GG	9W	320,86	318,06	-	190	102	65
115		3535	GG	9W	320,86	318,06	-	190	133	89	
170*	4040	GG	9W	320,86	318,06	-	230	187	102		
	80	40	3020	GG	9A	356,51	353,71	-	170	54	51
		55	3020	GG	9A	356,51	353,71	-	170	70	51
		85	3525	GG	9A	356,51	353,71	-	190	102	65
115		3535	GG	9A	356,51	353,71	-	190	133	89	
170	4040	GG	9W	356,51	353,71	-	230	187	102		
	90	40	3020	GG	9A	401,07	398,28	-	170	54	51
		55	3020	GG	9A	401,07	398,28	-	170	70	51
		85	3525	GG	9A	401,07	398,28	-	190	102	65
115		3535	GG	9A	401,07	398,28	-	190	133	89	
170	4040	GG	9A	401,07	398,28	-	230	187	102		
	112	40	3020	GG	9A	499,11	496,32	-	170	54	51
		55	3020	GG	9A	499,11	496,32	-	170	70	51
		85	3525	GG	9A	499,11	496,32	-	190	102	65
115		3535	GG	9A	499,11	496,32	-	190	133	89	
170	5050	GG	9A	499,11	496,32	-	265	187	127		
	144	40	3020	GG	9A	641,71	638,92	-	170	54	51
		55	3020	GG	9A	641,71	638,92	-	170	70	51
		85	3525	GG	9A	641,71	638,92	-	190	102	65
115		4040	GG	9A	641,71	638,92	-	230	133	102	
170	5050	GG	9A	641,71	638,92	-	265	187	127		
	168	40	3020	GG	9A	748,66	745,87	-	170	54	51
		55	3020	GG	9A	748,66	745,87	-	170	70	51
		85	3525	GG	9A	748,66	745,87	-	190	102	65
115		4040	GG	9A	748,66	745,87	-	230	133	102	
170	5050	GG	9A	748,66	745,87	-	265	187	127		
	192	40	3020	GG	9A	855,62	852,82	-	170	54	51
		55	3020	GG	9A	855,62	852,82	-	170	70	51
		85	4040	GG	3A	855,62	852,82	-	230	102	102
115		4040	GG	9A	855,62	852,82	-	230	133	102	
170*	5050	GG	9A	855,62	852,82	-	265	187	127		
	216	40	3020	GG	9A	962,57	959,76	-	170	54	51
		55	3535	GG	7A	962,57	959,76	-	190	70	89
		85	4040	GG	3A	962,57	959,76	-	230	102	102
115*		4040	GG	9A	962,57	959,76	-	230	133	102	
170*	5050	GG	9A	962,57	959,76	-	265	187	127		
	264	40	4040	GG	7A	1176,5	1173,7	-	230	54	102
		55	4040	GG	7A	1176,5	1173,7	-	230	70	102
		85	4040	GG	3A	1176,5	1173,7	-	230	102	102

OSZUBENÉ ŘEMENICE GT PC

PRO KUŽELOVÉ POUZDRO TB

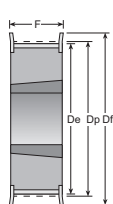

TYP 3F

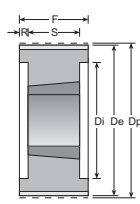

TYP 4

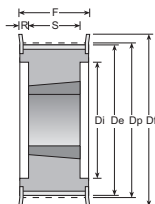

TYP 4F

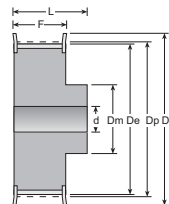

TYP 6F

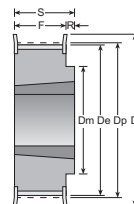

TYP 8F

Vzor označení

22S - 8MGT PC - 12

32S - 8MGT PC - 21 TB 1610

8MGT PC (TB)				POLYCHAIN						
Počet zubů	Pro šířku řemenu	Číslo TB pouzdra	Materiál	Typ	Dp	De	Df	Dm	F	S
22	12	náboj	ST	6F	56,02	54,42	60	43	20	30
21	náboj	ST	6F	56,02	54,42	60	43	30	42	
25	12	1108	ST	8F	63,66	62,06	70	49	20	22
21	1108	ST	3F	63,66	62,06	70	-	30	22	
36	náboj	ST	6F	63,66	62,06	70	49	45	55	
28	12	1108	ST	8F	71,30	69,70	75	56	20	22
21	1210	ST	3F	71,30	69,70	75	-	30	25	
36	1210	ST	3F	71,30	69,70	75	-	45	25	
30	12	1210	ST	8F	76,39	74,79	82,5	60	20	25
21	1210	ST	3F	76,39	74,79	82,5	-	30	25	
36	1610	ST	3F	76,39	74,79	82,5	-	45	25	
62	náboj	ST	6F	76,39	74,79	82,5	63	72	84	
32	12	1610	ST	8F	81,49	79,89	87	66	20	25
21	1610	ST	3F	81,49	79,89	87	-	30	25	
36	1610	ST	3F	81,49	79,89	87	-	45	25	
62	náboj	ST	6F	81,49	79,89	87	68	72	84	
34	12	1610	ST	8F	86,58	84,98	91	69	20	25
21	1610	ST	3F	86,58	84,98	91	-	30	25	
36	1610	ST	3F	86,58	84,98	91	-	45	25	
62	náboj	ST	6F	86,58	84,98	91	69	72	84	
36	12	1610	ST	8F	91,67	90,07	97	76	20	25
21	1610	ST	3F	91,67	90,07	97	-	30	25	
36	1610	ST	3F	91,67	90,07	97	-	45	25	
62	náboj	ST	6F	91,67	90,07	97	76	72	84	
38	12	1610	ST	8F	96,77	95,17	102	78	20	25
21	1610	ST	3F	96,77	95,17	102	-	30	25	
36	1610	ST	3F	96,77	95,17	102	-	45	25	
62	náboj	ST	6F	96,77	95,17	102	78	72	84	
40	12	1610	ST	8F	101,86	100,26	106	85	20	25
21	1610	ST	3F	101,86	100,26	106	-	30	25	
36	2012	ST	3F	101,86	100,26	106	-	45	32	
62	2012	ST	3F	101,86	100,26	106	-	72	32	
45	12	2012	ST	8F	114,59	112,99	120	92	20	32
21	2012	ST	8F	114,59	112,99	120	92	30	32	
36	2012	ST	3F	114,59	112,99	120	-	45	32	
62	2012	ST	3F	114,59	112,99	120	-	72	32	
48	12	2012	ST	8F	122,23	120,63	128	103	20	32
21	2012	ST	8F	122,23	120,63	128	103	30	32	
36	2012	ST	3F	122,23	120,63	128	-	45	32	
62	2517	ST	3F	122,23	120,63	128	-	72	45	

Počet zubů	Pro šířku řemenu	Číslo TB pouzdra	Materiál	Typ	Dp	De	Df	Dm	F	S
50	12	2012	ST	8F	127,32	125,72	135	104	20	32
21	2012	ST	8F	127,32	125,72	135	104	30	32	
36	2012	ST	3F	127,32	125,72	135	-	45	32	
62	2517	ST	3F	127,32	125,72	135	-	72	45	
56	12	2012	ST	8F	142,60	141,00	150	104	20	32
21	2012	ST	8F	142,60	141,00	150	104	30	32	
36	2517	ST	3F	142,60	141,00	150	-	45	45	
62	2517	ST	4F	142,60	141,00	150	-	72	45	
60	12	2012	ST	8F	152,79	151,19	158	111	20	32
21	2517	ST	8F	152,79	151,19	158	124	30	45	
36	2517	ST	3F	152,79	151,19	158	-	45	45	
62	2517	ST	4F	152,79	151,19	158	-	72	45	
64	12	2012	ST	8F	162,97	161,37	168	111	20	32
21	2517	ST	8F	162,97	161,37	168	124	30	45	
36	2517	ST	3F	162,97	161,37	168	-	45	45	
62	2517	ST	4F	162,97	161,37	168	-	72	45	
75	12	2012	ST	8	190,99	189,39	-	111	20	32
21	2517	ST	8	190,99	189,39	-	124	30	45	
36	3020	ST	8	190,99	189,39	-	150	45	51	
62	3020	ST	4	190,99	189,39	-	-	72	51	
80	12	2012	ST	8	203,72	202,12	-	111	20	32
21	2517	ST	8	203,72	202,12	-	124	30	45	
36	3020	ST	8	203,72	202,12	-	150	45	51	
62	3020	ST	4	203,72	202,12	-	-	72	51	
90	12	2012	ST	8	229,18	227,58	-	111	20	32
21	2517	ST	8	229,18	227,58	-	124	30	45	
36	3020	ST	7W	229,18	227,58	-	150	45	51	
62	3020	ST	4	229,18	227,58	-	-	72	51	
112	21	2517	GG	7W	285,21	283,61	-	124	30	45
36	3020	GG	7W	285,21	283,61	-	150	45	51	
62	3020	GG	9W	285,21	283,61	-	198	72	51	
140	21	3020	GG	7A	356,51	354,91	-	150	30	51
36	3020	GG	7A	356,51	354,91	-	150	45	51	
62	3525	GG	9W	356,51	354,91	-	150	72	65	
168	36	3525	GG	7A	427,81	426,21	-	198	45	65
62	3525	GG	9A	427,81	426,21	-	198	72	65	
192	36	3525	GG	7A	488,91	487,32	-	198	45	65
62	3525	GG	9A	488,91	487,32	-	198	72	65	

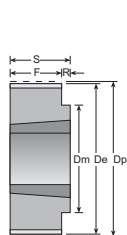

TYP 8

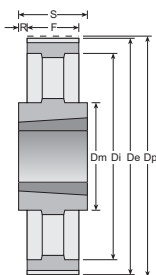

TYP 7A

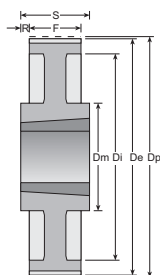

TYP 7W

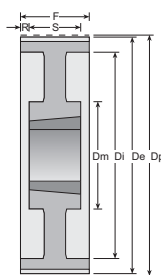

TYP 9W

OZUBENÉ ŘEMENICE GT PC

PRO KUŽELOVÉ POUZDRO TB

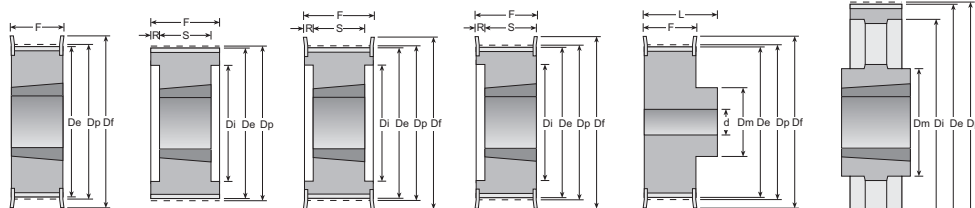

TYP 3F

TYP 4

TYP 4F

TYP 5F

TYP 6F

TYP 7A

Vzor označení

28S - 14MGT PC - 20

38S - 14MGT PC - 20 TB 2517

14MGT PC (TB)

POLYCHAIN

Počet zubů	Pro šířku řemenu	Číslo TB pouzdra	Material	Typ	Dp	De	Df	Dm	F	S
28	20	2012	ST	3F	124,78	121,98	128	-	33	32
37	2012	ST	5F	124,78	121,98	128	-	51	32	
30	20	2012	ST	3F	133,69	130,89	138	-	33	32
37	2517	ST	4F	133,69	130,89	138	-	51	45	
32	20	2012	ST	3F	142,60	139,80	154	-	33	32
37	2517	ST	4F	142,60	139,80	154	-	51	45	
34	20	2517	ST	8F	151,52	148,72	160	117	33	45
37	2517	ST	4F	151,52	148,72	160	-	51	45	
68	náboj	ST	6F	151,52	148,72	160	132	84	104	
36	20	2517	ST	8F	160,43	157,63	168	117	33	45
37	2517	ST	5F	160,43	157,63	168	-	51	45	
68	náboj	ST	6F	160,43	157,63	168	131	84	104	
90	náboj	ST	6F	160,43	157,63	168	131	106	136	
38	20	2517	ST	8F	169,34	166,54	183	117	33	45
37	2517	ST	5F	169,34	166,54	183	-	51	45	
68	náboj	ST	6F	169,34	166,54	183	141	84	104	
90	náboj	ST	6F	169,34	166,54	183	141	106	136	
125	náboj	ST	6F	169,34	166,54	183	141	141	161	
40	20	2517	ST	8F	178,25	175,45	188	117	33	45
37	2517	ST	5F	178,25	175,45	188	-	51	45	
68	náboj	ST	6F	178,25	175,45	188	156	84	104	
90	náboj	ST	6F	178,25	175,45	188	156	106	136	
125	náboj	ST	6F	178,25	175,45	188	156	141	161	
44	20	3020	ST	8F	196,08	193,28	211	144	33	51
37	3020	ST	3F	196,08	193,28	211	-	51	51	
68	3020	ST	4F	196,08	193,28	211	-	84	51	
90	náboj	ST	6F	196,08	193,28	211	169	106	136	
125	náboj	ST	6F	196,08	193,28	211	169	141	161	
48	20	3020	ST	8F	213,90	211,11	226	144	33	51
37	3020	ST	3F	213,90	211,11	226	-	51	51	
68	3020	ST	5F	213,90	211,11	226	-	84	51	
90	3525	ST	4F	213,90	211,11	226	-	106	66	
125	náboj	ST	6F	213,90	211,11	226	185	141	161	
50	20	3020	ST	8F	222,82	220,02	240	144	33	51
37	3020	ST	3F	222,82	220,02	240	-	51	51	
68	3525	ST	4F	222,82	220,02	240	-	84	65	
90	3525	ST	4F	222,82	220,02	240	-	106	66	
125	3525	ST	4F	222,82	220,02	240	-	141	65	
56	20	3020	ST	7WF	249,55	246,76	256	144	33	51
37	3020	ST	9WF	249,55	246,76	256	144	51	51	
68	3525	ST	4F	249,55	246,76	256	-	84	65	
90	3525	ST	4F	249,55	246,76	256	-	106	66	
125	3525	ST	4F	249,55	246,76	256	-	141	65	

Počet zubů	Pro šířku řemenu	Číslo TB pouzdra	Material	Typ	Dp	De	Df	Dm	F	S
60	20	3020	GG	7W	267,38	264,58	-	159	33	51
37	3020	GG	9W	267,38	264,58	-	159	51	51	
68	3525	ST	4	267,38	264,58	-	-	84	65	
90	3525	ST	4	267,38	264,58	-	-	106	66	
125	4030	ST	4	267,38	264,58	-	-	141	76	
64	20	3020	GG	7W	285,21	282,41	-	159	33	51
37	3020	GG	9W	285,21	282,41	-	159	51	51	
68	3525	GG	4	285,21	282,41	-	-	84	65	
90	3525	GG	4	285,21	282,41	-	-	106	66	
125	4030	GG	4	285,21	282,41	-	-	141	76	
72	20	3020	GG	7W	320,86	318,06	-	159	33	51
37	3020	GG	9W	320,86	318,06	-	159	51	51	
68	3525	GG	9W	320,86	318,06	-	178	84	65	
90	3525	GG	9W	320,86	318,06	-	178	106	66	
125	4030	GG	9W	320,86	318,06	-	215	141	76	
80	20	3020	GG	7W	356,51	353,71	-	159	33	51
37	3020	GG	9W	356,51	353,71	-	159	51	51	
68	3525	GG	9W	356,51	353,71	-	178	84	65	
90	4030	GG	9W	356,51	353,71	-	215	106	76	
125	4030	GG	9W	356,51	353,71	-	215	141	76	
90	20	3020	GG	7A	401,07	398,27	-	159	33	51
37	3020	GG	9A	401,07	398,27	-	159	51	51	
68	3525	GG	9A	401,07	398,27	-	178	84	65	
90	4030	GG	9W	401,07	398,27	-	215	106	76	
125	4030	GG	9W	401,07	398,27	-	215	141	76	
112	20	3020	GG	7A	499,11	496,31	-	159	33	51
37	3020	GG	9A	499,11	496,31	-	159	51	51	
68	3525	GG	9A	499,11	496,31	-	178	84	65	
90	4535	GG	9A	499,11	496,31	-	215	106	90	
125	4535	GG	9A	499,11	496,31	-	215	141	89	
140	20	3020	GG	7A	623,89	621,09	-	159	33	51
37	3525	GG	7A	623,89	621,09	-	206	51	65	
68	3525	GG	9A	623,89	621,09	-	206	84	65	
90	4535	GG	9A	623,89	621,09	-	215	106	90	
125	4535	GG	9A	623,89	621,09	-	215	141	89	
168	37	3525	GG	7A	748,66	745,87	-	206	51	65
68	3525	GG	9A	748,66	745,87	-	206	84	65	
90	5040	GG	9A	748,66	745,87	-	267	106	102	
125	5040	GG	9A	748,66	745,87	-	267	141	102	
192	37	4030	GG	7A	855,61	852,82	-	215	51	76
68	4030	GG	9A	855,61	852,82	-	215	84	76	
90	5040	GG	9A	855,61	852,82	-	267	106	102	
125	5040	GG	9A	855,61	852,82	-	267	141	102	

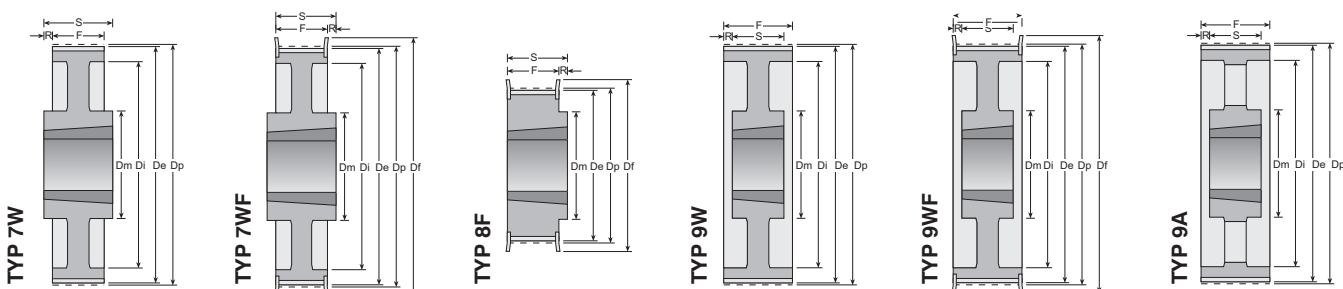

OZUBENÉ ŘEMENICE SILENTSYNC

S PLNÝM PŘEDVRTANÝM NÁBOJEM

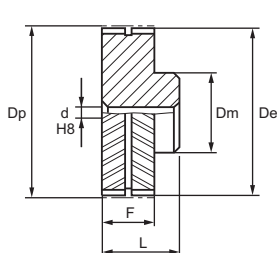

TYP 1

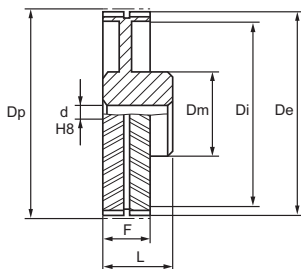

TYP 2

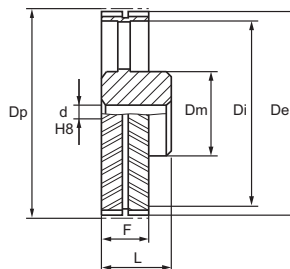

TYP 3

Vzor označení
Silentsync Y - 18S - MPB

SILENTSYNC Y pro šířku řemenu 16 mm 8M

Počet zubů	Materiál	Typ	Dp	De	Di	Dm	F	L	d max	d
18	ST, GG	1	45,84	44,47	-	38,7	17	27	26	12,7
20	ST, GG	1	50,93	49,56	-	40,7	17	29	27	12,7
22	ST, GG	1	56,02	54,65	-	45,9	17	29	31	12,7
24	ST, GG	1	61,12	59,75	-	51	17	33	34	12,7
25	ST, GG	1	63,66	62,29	-	53,5	17	33	36	12,7
26	ST, GG	1	66,21	64,84	-	57,8	17	33	39	12,7
28	ST, GG	1	71,30	69,93	-	61	17	33	41	12,7
30	ST, GG	1	76,40	75,03	-	67	17	33	45	12,7
32	ST, GG	1	81,49	80,12	-	72	17	33	48	12,7
34	ST, GG	1	86,58	85,21	-	77	17	33	51	12,7
36	ST, GG	1	91,68	90,30	-	82	17	33	55	12,7
38	ST, GG	1	96,77	95,40	-	87	17	33	58	12,7
40	ST, GG	1	101,86	100,49	-	92	17	33	62	12,7
44	ST, GG	1	112,05	110,68	-	102	17	33	68	12,7
45	ST, GG	1	114,59	113,22	-	105	17	33	70	12,7
48	ST, GG	1	122,23	120,86	-	112	17	33	75	12,7

SILENTSYNC Y pro šířku řemenu 16 mm 8M

Počet zubů	Materiál	Typ	Dp	De	Di	Dm	F	L	d max	d
50	ST, GG	1	127,33	125,96	-	118	17	33	79	12,7
52	ST, GG	1	132,42	131,05	-	123	17	33	82	12,7
56	ST, GG	1	142,61	141,24	-	133	17	33	89	12,7
60	ST, GG	1	152,79	151,42	-	143	17	33	96	12,7
63	ST, GG	2	160,43	159,06	135	110	17	33	73	12,7
64	ST, GG	2	162,98	161,61	138	110	17	33	74	12,7
68	ST, GG	2	173,17	171,79	148	110	17	33	74	12,7
72	ST, GG	2	183,35	181,98	158	110	17	33	74	12,7
75	ST, GG	2	190,99	189,62	166	110	17	33	73	12,7
76	ST, GG	2	193,54	192,17	168	110	17	33	74	12,7
80	ST, GG	2	203,72	202,35	178	110	17	33	73	12,7
90	ST, GG	2	229,19	227,82	204	110	17	33	73	25,4
112	GG	2	285,21	283,84	260	110	17	33	73	25,4
140	GG	2	356,52	355,15	331	110	17	33	73	25,4
180	GG	3	458,38	457,01	433	150	17	33	100	25,4
224	GG	3	570,43	569,06	545	150	17	33	100	25,4

SILENTSYNC M pro šířku řemenu 25 mm 8M

Počet zubů	Materiál	Typ	Dp	De	Di	Dm	F	L	d max	d
20	AL	1	50,93	49,56	-	41	26	38	27	12,7
22	AL	1	56,02	54,65	-	46	26	38	31	12,7
24	AL	1	61,12	59,75	-	51	26	42	34	12,7
26	AL	1	66,21	64,84	-	58	26	42	39	12,7
28	AL	1	71,30	69,93	-	62	26	42	41	12,7
30	AL	1	76,40	75,03	-	67	26	42	45	12,7
32	AL	1	81,49	80,12	-	72	26	42	48	12,7

SILENTSYNC M pro šířku řemenu 25 mm 8M

Počet zubů	Materiál	Typ	Dp	De	Di	Dm	F	L	d max	d
34	AL	1	86,58	85,21	-	77	26	42	51	12,7
36	AL	1	91,68	90,30	-	82	26	42	55	12,7
38	AL	1	96,77	95,40	-	87	26	42	58	12,7
40	AL	1	101,86	100,49	-	92	26	42	62	12,7
56	AL	1	142,61	141,24	-	133	26	42	89	12,7
90	AL	2	229,19	227,82	204	120	26	42	80	25,4

SILENTSYNC W pro šířku řemenu 32 mm 8M

Počet zubů	Materiál	Typ	Dp	De	Di	Dm	F	L	d max	d
18	ST, GG	1	45,84	44,47	-	38,7	33	43	26	12,7
20	ST, GG	1	50,93	49,56	-	40,7	33	45	27	12,7
22	ST, GG	1	56,02	54,65	-	45,9	33	45	31	12,7
24	ST, GG	1	61,12	59,75	-	51	33	49	34	12,7
25	ST, GG	1	63,66	62,29	-	53,5	33	49	36	12,7
26	ST, GG	1	66,21	64,84	-	57,8	33	49	39	12,7
28	ST, GG	1	71,30	69,93	-	62	33	49	41	12,7
30	ST, GG	1	76,40	75,03	-	67	33	49	45	12,7
32	ST, GG	1	81,49	80,12	-	72	33	49	48	12,7
34	ST, GG	1	86,58	85,21	-	77	33	49	51	12,7
36	ST, GG	1	91,68	90,30	-	82	33	49	55	12,7
38	ST, GG	1	96,77	95,40	-	87	33	49	58	12,7
40	ST, GG	1	101,86	100,49	-	92	33	49	62	12,7
44	ST, GG	1	112,05	110,68	-	102	33	49	68	12,7
45	ST, GG	1	114,59	113,22	-	105	33	49	70	12,7
48	ST, GG	1	122,23	120,86	-	113	33	49	75	12,7

SILENTSYNC W pro šířku řemenu 32 mm 8M

Počet zubů	Materiál	Typ	Dp	De	Di	Dm	F	L	d max	d
50	ST, GG	1	127,33	125,96	-	118	33	49	79	12,7
52	ST, GG	1	132,42	131,05	-	123	33	49	82	12,7
56	ST, GG	1	142,61	141,24	-	133	33	49	89	12,7
60	ST, GG	1	152,79	151,42	-	143	33	49	96	12,7
63	ST, GG	1	160,43	159,06	-	151	33	49	101	12,7
64	ST, GG	1	162,98	161,61	-	153	33	49	102	12,7
68	ST, GG	2	173,17	171,79	148	120	33	49	80	12,7
72	ST, GG	2	183,35	181,98	158	120	33	49	80	12,7
75	ST, GG	2	190,99	189,62	166	120	33	49	80	25,4
76	ST, GG	2	193,54	192,17	168	120	33	49	80	12,7
80	ST, GG	2	203,72	202,35	178	120	33	49	80	25,4
90	ST, GG	2	229,19	227,82	204	120	33	49	80	25,4
112	GG	2	285,21	283,84	260	120	33	49	80	25,4
140	GG	2	356,52	355,15	331	150	33	49	100	25,4
180	GG	3	458,38	457,01	433	150	33	49	100	25,4
224	GG	3	570,43	569,06	545	150	33	49	100	25,4

ŮZUBENÉ ŘEMENICE SILENTSYNC

S PLNÝM PŘEDVRTANÝM NÁBOJEM

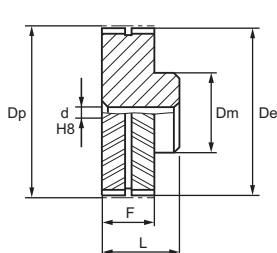

TYP 1

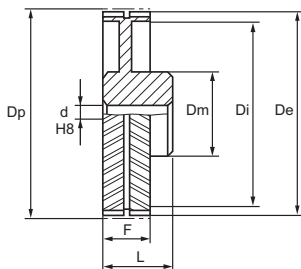

TYP 2

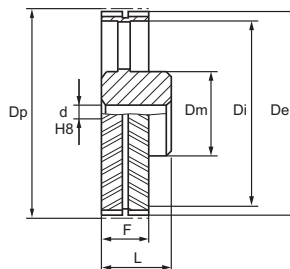

TYP 3

Vzor označení
Silentsync P - 28S - MPB

SILENTSYNC L pro šířku řemenu 50 mm 8M

Počet zubů	Materiál	Typ	Dp	De	Di	Dm	F	L	d max	d
20	AL	1	50,93	49,56	-	41	51	63	27	12,7
22	AL	1	56,02	54,65	-	46	51	63	31	12,7
24	AL	1	61,12	59,75	-	51	51	67	34	12,7
26	AL	1	66,21	64,84	-	58	51	67	39	12,7
28	AL	1	71,30	69,93	-	62	51	67	41	12,7
30	AL	1	76,40	75,03	-	67	51	67	45	12,7
32	AL	1	81,49	80,12	-	72	51	67	48	12,7

SILENTSYNC P pro šířku řemenu 64 mm 8M

Počet zubů	Materiál	Typ	Dp	De	Di	Dm	F	L	d max	d
34	AL	1	86,58	85,21	-	77	51	67	51	12,7
36	AL	1	91,68	90,30	-	82	51	67	55	12,7
38	AL	1	96,77	95,40	-	87	51	67	58	12,7
40	AL	1	101,86	100,49	-	92	51	67	62	12,7
56	AL	1	142,61	141,24	-	133	51	67	89	12,7
90	AL	2	229,19	227,82	204	120	51	67	80	25,4

SILENTSYNC P pro šířku řemenu 64 mm 8M

Počet zubů	Materiál	Typ	Dp	De	Di	Dm	F	L	d max	d
20	ST, GG	1	50,93	49,56	-	40,7	65	85	27	12,7
22	ST, GG	1	56,02	54,65	-	45,9	65	85	31	12,7
24	ST, GG	1	61,12	59,75	-	51	65	85	34	12,7
25	ST, GG	1	63,66	62,29	-	53,5	65	85	36	12,7
26	ST, GG	1	66,21	64,84	-	57,8	65	85	39	12,7
28	ST, GG	1	71,30	69,93	-	62	65	85	41	12,7
30	ST, GG	1	76,40	75,03	-	67	65	85	45	12,7
32	ST, GG	1	81,49	80,12	-	72	65	85	48	12,7
34	ST, GG	1	86,58	85,21	-	77	65	85	51	12,7
36	ST, GG	1	91,68	90,30	-	82	65	85	55	12,7
38	ST, GG	1	96,77	95,40	-	87	65	85	58	12,7
40	ST, GG	1	101,86	100,49	-	92	65	85	62	12,7
44	ST, GG	1	112,05	110,68	-	102	65	85	68	12,7
45	ST, GG	1	114,59	113,22	-	105	65	85	70	12,7
48	ST, GG	1	122,23	120,86	-	113	65	85	75	25,4

SILENTSYNC B pro šířku řemenu 35 mm 14M

Počet zubů	Materiál	Typ	Dp	De	Di	Dm	F	L	d max	d
50	ST, GG	1	127,33	125,96	-	118	65	85	79	25,4
52	ST, GG	1	132,42	131,05	-	123	65	85	82	25,4
56	ST, GG	1	142,61	141,24	-	133	65	85	89	25,4
60	ST, GG	1	152,79	151,42	-	143	65	85	96	25,4
63	ST, GG	1	160,43	159,06	-	151	65	85	101	25,4
64	ST, GG	1	162,98	161,61	-	154	65	85	102	25,4
68	ST, GG	1	173,17	171,79	148	120	65	85	108	25,4
72	ST, GG	1	183,35	181,98	158	120	65	85	115	25,4
75	ST, GG	1	190,99	189,62	166	120	65	85	120	25,4
76	ST, GG	1	193,54	192,17	168	120	65	85	120	25,4
80	ST, GG	1	203,72	202,35	178	120	65	85	125	25,4
90	ST, GG	2	229,19	227,82	204	120	65	85	80	25,4
112	GG	2	285,21	283,84	264	120	65	85	80	25,4
140	GG	2	356,52	355,15	331	150	65	85	100	25,4
180	GG	3	458,38	457,01	433	150	65	85	100	25,4

SILENTSYNC B pro šířku řemenu 35 mm 14M

Počet zubů	Materiál	Typ	Dp	De	Di	Dm	F	L	d max	d
28	ST, GG	1	124,78	121,99	-	105	37	53	70	25,4
30	ST, GG	1	133,69	130,90	-	114	37	53	76	25,4
32	ST, GG	1	142,61	139,81	-	123	37	53	82	25,4
34	ST, GG	1	151,52	148,73	-	132	37	53	88	25,4
36	ST, GG	1	160,43	157,64	-	141	37	53	94	25,4
38	ST, GG	1	169,35	166,55	-	150	37	53	100	25,4
40	ST, GG	1	178,26	175,46	-	159	37	53	106	25,4
43	ST, GG	1	191,63	188,83	-	172	37	53	115	25,4
45	ST, GG	1	200,54	197,75	-	181	37	53	121	25,4
48	ST, GG	1	213,91	211,12	-	195	37	53	130	25,4
50	ST, GG	2	222,82	220,03	180	150	37	53	100	25,4

SILENTSYNC B pro šířku řemenu 35 mm 14M

Počet zubů	Materiál	Typ	Dp	De	Di	Dm	F	L	d max	d
56	ST, GG	2	249,56	246,77	207	150	37	53	100	25,4
60	GG	2	267,39	264,59	225	150	37	53	100	25,4
63	GG	2	280,76	277,96	238	150	37	53	100	25,4
71	GG	2	316,41	313,62	274	150	37	53	100	25,4
75	GG	2	334,24	331,44	291	150	37	53	100	25,4
80	GG	2	356,52	353,72	314	150	37	53	100	25,4
90	GG	2	401,08	398,29	358	150	37	53	100	25,4
112	GG	3	499,12	496,33	456	150	37	53	100	25,4
140	GG	3	623,91	621,11	581	150	37	53	100	25,4
168	GG	3	748,69	745,89	706	150	37	53	100	25,4

Řemenice SILENTSYNC B lze dodat i v provedení pro pouzdro TB.

OSUBENÉ ŘEMENICE SILENTSYNC

S PLNÝM PŘEDVRTANÝM NÁBOJEM

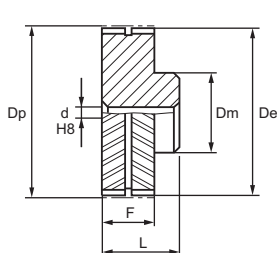

TYP 1

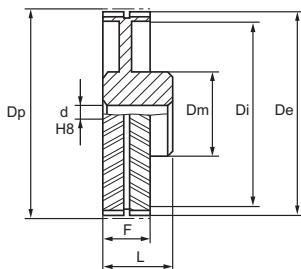

TYP 2

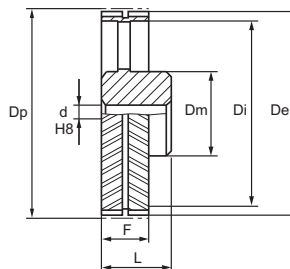

TYP 3

Vzor označení
Silentsync G - 28S - MPB

SILENTSYNC G pro šířku řemenu 52,5 mm 14M										
Počet zubů	Materiál	Typ	Dp	De	Di	Dm	F	L	d max	d
28	ST, GG	1	124,78	121,99	-	109	54,5	74,5	73	25,4
30	ST, GG	1	133,69	130,90	-	117,5	54,5	74,5	78	25,4
32	ST, GG	1	142,61	139,81	-	126,5	54,5	74,5	84	25,4
34	ST, GG	1	151,52	148,73	-	135,5	54,5	70,5	90	25,4
36	ST, GG	1	160,43	157,64	-	141	54,5	70,5	94	25,4
38	ST, GG	1	169,35	166,55	-	150	54,5	70,5	100	25,4
40	ST, GG	1	178,26	175,46	-	159	54,5	70,5	106	25,4
43	ST, GG	1	191,63	188,83	-	172	54,5	70,5	115	25,4
45	ST, GG	1	200,54	197,75	-	181	54,5	70,5	121	25,4
48	ST, GG	1	213,91	211,12	-	195	54,5	70,5	130	25,4
50	ST, GG	2	222,82	220,03	180	150	54,5	70,5	100	25,4

Počet zubů	Materiál	Typ	Dp	De	Di	Dm	F	L	d max	d
56	ST, GG	2	249,56	246,77	207	150	54,5	70,5	100	25,4
60	GG	2	267,39	264,59	225	150	54,5	70,5	100	25,4
63	GG	2	280,76	277,96	238	150	54,5	70,5	100	25,4
71	GG	2	316,41	313,62	274	150	54,5	70,5	100	25,4
75	GG	2	334,24	331,44	291	150	54,5	70,5	100	25,4
80	GG	2	356,52	353,72	314	150	54,5	70,5	100	25,4
90	GG	2	401,08	398,29	358	180	54,5	70,5	120	25,4
112	GG	3	499,12	496,33	456	180	54,5	70,5	120	25,4
140	GG	3	623,91	621,11	581	200	54,5	70,5	133	25,4
168	GG	3	748,69	745,89	706	200	54,5	70,5	133	25,4

Řemence SILENTSYNC G lze dodat i v provedení pro pouzdro TB.

SILENTSYNC O pro šířku řemenu 70 mm 14M										
Počet zubů	Materiál	Typ	Dp	De	Di	Dm	F	L	d max	d
28	ST, GG	1	124,78	121,99	-	109	72	92	73	25,4
30	ST, GG	1	133,69	130,90	-	117,5	72	92	78	25,4
32	ST, GG	1	142,61	139,81	-	126,5	72	98	84	25,4
34	ST, GG	1	151,52	148,73	-	135,5	72	98	90	25,4
36	ST, GG	1	160,43	157,64	-	144	72	98	95	25,4
38	ST, GG	1	169,35	166,55	-	153	72	98	101	25,4
40	ST, GG	1	178,26	175,46	-	162	72	98	107	25,4
43	ST, GG	1	191,63	188,83	-	174	72	98	116	25,4
45	ST, GG	1	200,54	197,75	-	183	72	88	122	25,4
48	ST, GG	1	213,91	211,12	-	197	72	88	131	25,4
50	ST, GG	1	222,82	220,03	-	205	72	88	137	25,4

Počet zubů	Materiál	Typ	Dp	De	Di	Dm	F	L	d max	d
56	ST, GG	1	249,56	246,77	-	230	72	88	153	25,4
60	GG	2	267,39	264,59	225	150	72	88	100	25,4
63	GG	2	280,76	277,96	238	150	72	88	100	25,4
71	GG	2	316,41	313,62	274	150	72	88	100	25,4
75	GG	2	334,24	331,44	291	180	72	88	120	25,4
80	GG	2	356,52	353,72	314	180	72	88	120	25,4
90	GG	2	401,08	398,29	358	200	72	88	133	25,4
112	GG	3	499,12	496,33	456	200	72	88	133	25,4
140	GG	3	623,91	621,11	581	220	72	88	147	25,4
168	GG	3	748,69	745,89	706	220	72	88	147	25,4

Řemence SILENTSYNC O lze dodat i v provedení pro pouzdro TB.

SILENTSYNC R pro šířku řemenu 105 mm 14M										
Počet zubů	Materiál	Typ	Dp	De	Di	Dm	F	L	d max	d
28	ST, GG	1	124,78	121,99	-	109	107	133	73	25,4
30	ST, GG	1	133,69	130,90	-	117,5	107	133	78	25,4
32	ST, GG	1	142,61	139,81	-	126,5	107	133	84	25,4
34	ST, GG	1	151,52	148,73	-	135,5	107	133	90	25,4
36	ST, GG	1	160,43	157,64	-	144	107	133	96	25,4
38	ST, GG	1	169,35	166,55	-	153	107	133	102	25,4
40	ST, GG	1	178,26	175,46	-	162	107	133	108	25,4
43	ST, GG	1	191,63	188,83	-	175	107	133	117	25,4
45	ST, GG	1	200,54	197,75	-	183	107	123	122	25,4
48	ST, GG	1	213,91	211,12	-	197	107	123	131	25,4
50	ST, GG	1	222,82	220,03	-	205	107	123	137	25,4

Počet zubů	Materiál	Typ	Dp	De	Di	Dm	F	L	d max	d
56	GG	1	249,56	246,77	-	230	107	123	153	25,4
60	GG	2	267,39	264,59	225	180	107	123	120	25,4
63	GG	2	280,76	277,96	238	180	107	123	120	25,4
71	GG	2	316,41	313,62	274	200	107	123	133	25,4
75	GG	2	334,24	331,44	291	200	107	123	133	25,4
80	GG	2	356,52	353,72	314	200	107	123	133	25,4
90	GG	2	401,08	398,29	358	220	107	123	147	25,4
112	GG	3	499,12	496,33	456	220	107	123	147	25,4
140	GG	3	623,91	621,11	581	240	107	123	160	25,4
168	GG	3	748,69	745,89	706	240	107	123	160	25,4

Řemence SILENTSYNC R lze dodat i v provedení pro pouzdro TB.