

Pístnicové a pístní těsnící manžety

Těsnící manžety slouží k utěsnění vzájemně pohyblivých strojních dílů válcového tvaru (nejčastěji se jedná o hydraulické a pneumatické písty a pístnice) při přímočarém posuvném pohybu. Princip těsnění manžetou spočívá v působení tlaku těsněným médiem na její pracovní část (břítu). Znamená to tedy, že břítu manžety jsou přitlačovány ke stýčným plochám těsněných součástí silou, která je přímo úměrná velikosti tlaku těsněného média.

Manžeta musí mít v klidové poloze zajištěno radiální předpětí, které je vytvořeno přesazením těsnících břítů oproti velikosti zástavbového prostoru. Je-li zvětšena vůle mezi pohybujícími se částmi, či je manžeta vtlačována do spáry, je třeba použít opěrného kroužku manžety. U hydraulických pracovních systémů se doporučuje pracovní látku chladit, aby nedocházelo ke snižování životnosti manžet. Manžety nesmí v žádném případě vytvářet vedení pohybujících se částí. Vedení musí zajistit vodící pásy a kroužky z kovu nebo plastu. Manžety umísťujeme právě v blízkosti těchto vedení.

Pro volbu vhodného těsnění je nutno znát tyto parametry:

- tlak
- teplota
- rychlost posuvu
- médium

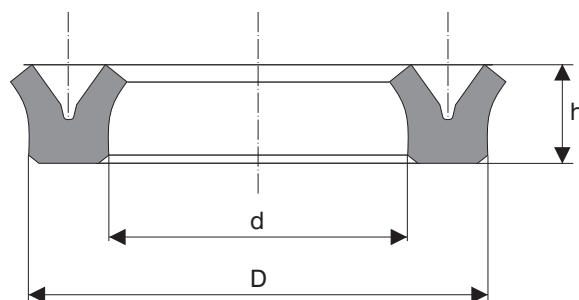

Měření a označování těsnících manžet

d = vnitřní průměr zástavbového prostoru pro danou manžetu:

tento rozměr naleznete u manžety na jejím vnitřním průměru přibližně v polovině její výšky. U miskových manžet je to průměr otvoru v manžetě.

D = vnější průměr zástavbového prostoru pro danou manžetu:

tento rozměr naleznete přibližně v polovině její výšky (ne na břitech). Rozdíl mezi udanou hodnotou vnějšího, ale i vnitřního průměru zástavbového prostoru, který se měří přibližně v polovině výšky manžety a hodnotou naměřenou na krajích břítů, je vlastně přesazení manžety oproti těsněným plochám, které v provozu zajišťuje správné radiální předpětí.

h = výška manžety: hodnota naměřená od patky k nejvyššímu místu manžety

S = výška zástavbového prostoru pro manžetu:

hodnota S by měla být větší přibližně o 10 - 15 % než hodnota h. Přesné hodnoty S, jakož i další technické údaje (např. drsnost a sklony zástavbových prostorů) je možno získat telefonickým dotazem. Tyto údaje již spíše slouží konstruktérům než obchodníkům.

Těsnění pístní (přetaženo na píst)

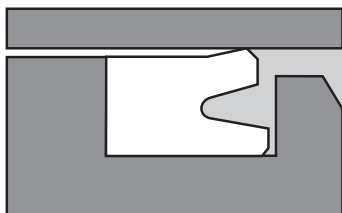

Těsnění pístnicové (vloženo do drážky válce)

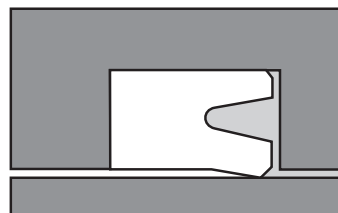

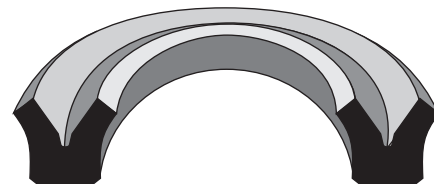

Nabízené typy českých manžet - Rubena

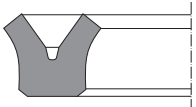
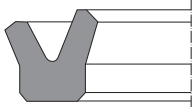
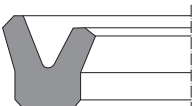
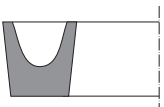
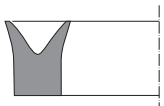
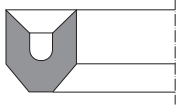
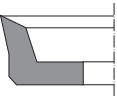

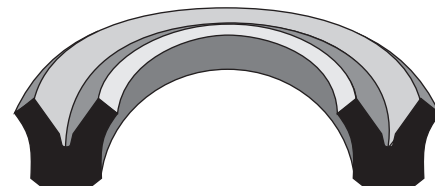
<p>ČSN 029269 univerzální</p> 	<p>Materiál: NBR 3158 - 029269.1 max.tlak do 10 MPa pracovní teplota -30+80°C PU 8159 - 029269.3 max.tlak do 16 MPa pracovní teplota -30+80°C</p> <p>Rychlost posuvu: max. 0,5 ms⁻¹</p> <p>Vlastnosti: univerzální drážkové symetrické manžety jsou určeny k těsnění pístů a pístnic hydraulických zařízení. Manžety jsou tvarovou obdobou pístních a pístnicových manžet PN 029274 a PN 029275. Díky tvarovému provedení mohou být však použity jako univerzální pro píst i pro pístnici. Zahraniční obdobou je typ MA25 (pro vyšší tlaky) nebo MA21 (pro nižší tlaky). Rozměry: viz. rozměrová řada</p>
<p>PN 029274 pístní</p> 	<p>Materiál: PU 8158 - 029274.1 max.tlak do 16 MPa pracovní teplota -30+80°C PU 8159 - 029274.2 max.tlak do 32 MPa pracovní teplota -30+80°C</p> <p>Rychlost posuvu: max. 0,5 ms⁻¹</p> <p>Vlastnosti: drážkové manžety UE jsou určeny k utěsnění pístů hydraulických zařízení. Jsou určeny pro lehká a středně těžká použití. Asymetrický tvar - vyšší vnitřní břit, umožňuje pevné zajištění a usazení manžety v drážce pístu. Zahraniční obdobou je typ MA28 (pro vyšší tlaky) a MA23 (pro nižší tlaky) nebo typ T18 Merkel. Rozměry: viz. rozměrová řada</p>
<p>PN 029275 pístnicová</p> 	<p>Materiál: PU 8158 - 029275.1 max.tlak do 16 MPa pracovní teplota -30+80°C PU 8159 - 029275.2 max.tlak do 32 MPa pracovní teplota -30+80°C</p> <p>Rychlost posuvu: max. 0,5 ms⁻¹</p> <p>Vlastnosti: drážkové manžety UI jsou určeny k utěsnění pístnic hydraulických zařízení. Jsou určeny pro lehká a středně těžká použití. Asymetrický tvar - vyšší venkovní břit, umožňuje pevné zajištění a usazení manžety v drážce pístnice. Zahraniční obdobou je typ MA30 (pro vyšší tlaky), MA24 (pro nižší tlaky) nebo typ T20 Merkel. Rozměry: viz. rozměrová řada</p>
<p>ČSN 029268 univerzální (pneumatická)</p> 	<p>Materiál: NBR 3158 029268 max.tlak do 1 MPa pracovní teplota -30+80°C</p> <p>Rychlost posuvu: max. 0,5 ms⁻¹</p> <p>Vlastnosti: manžety U jsou určeny k utěsnění pouze pneumatických zařízení při přímočarém posuvném pohybu. Stlačený vzduch musí obsahovat olejovou mlhu, pokud nemá pneumatické zařízení, jako například válec, vlastní mazání. Ve specifických případech použití je možno volit aplikaci této manžety s přítačným kroužkem (PN 029571) na poptávku. Rozměry: viz. rozměrová řada</p>
<p>ČSN 029260 univerzální U</p> 	<p>Materiál: NBR 3158 029260.3 max.tlak do 30 MPa pracovní teplota -30+80°C</p> <p>Rychlost posuvu: max. 0,5 ms⁻¹</p> <p>Vlastnosti: manžety jsou univerzální se symetrickým profilem. Slouží k utěsnění pístů a pístnic hydraulických zařízení. Díky svému tvaru jsou schopny těsnit tlaky až do 30MPa. Rozměry: viz. rozměrová řada</p>
<p>ČSN 029265 univerzální Y</p> 	<p>Materiál: NBR 3158 029265.3 max.tlak do 30 MPa pracovní teplota -30+80°C</p> <p>Vlastnosti: manžety jsou funkční obdobou profilu U. Používají se v hydraulických systémech. Patka manžety má však stříškovitý tvar a umožňuje sadování. (skládání jednotlivých manžet do sebe) podle výšky zástavbového prostoru. Tuto manžetu lze použít jako náhradního profilu, včetně novějších zařízení. Rozměry: viz. rozměrová řada</p>
<p>ČSN 029270 pístní M (pneumatická)</p> 	<p>Materiál: NBR 3158 029270 max.tlak do 3,2 MPa pracovní teplota -30+80°C</p> <p>Vlastnosti: miskové manžety M se používají jako pístní těsnění v pneumatických systémech. Stlačený vzduch musí obsahovat olejovou mlhu, pokud nemá pneumatické zařízení vlastní mazání. Rozměry: viz. rozměrová řada</p>

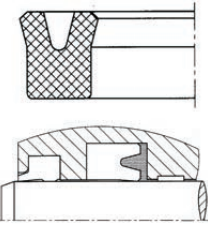
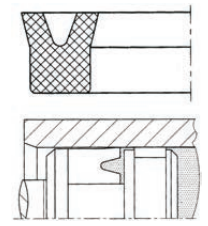
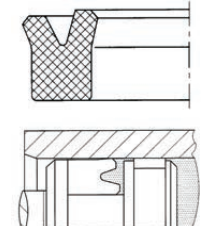
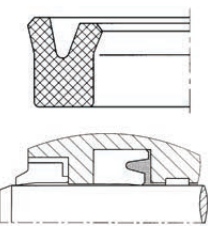
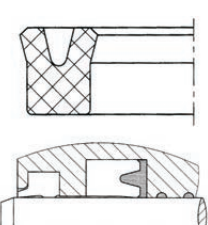
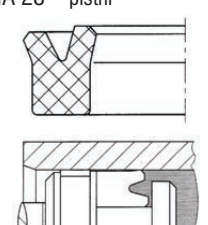

Nabízené typy zahraničních manžet - Dichtomatik

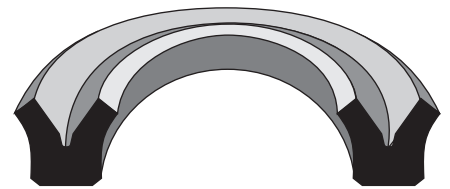
<p>MA 21 univerzální</p> 	<p>Materiál: NBR 90 tlak: 16 MPa 10 MPa 5 MPa pracovní teplota -30+100°C spára(mm): 0,1 0,15 0,2</p> <p>Rychlost posuvu: max. 0,5 ms⁻¹ Vlastnosti: univerzální těsnění pro hydrauliku a pneumatiku. Českou obdobou tohoto těsnění je typ dle ČSN 029269.1. Pro vyšší tlaky použijte typ MA 25.</p> <p>Rozměry: standardní viz. rozměrová řada, ostatní na poptávku.</p>
<p>MA 22 univerzální</p> 	<p>Materiál: NBR 90 tlak: 10 MPa 5 MPa pracovní teplota -30+100°C spára(mm) 0,15 0,2</p> <p>Rychlost posuvu: max. 0,5 ms⁻¹ Vlastnosti: univerzální těsnění pro hydrauliku. Pro tlaky od 1MPa by mělo být těsnění používáno s opěrným kroužkem umístěným na čelní stěně.</p> <p>Rozměry: standardní viz. rozměrová řada, ostatní na poptávku.</p>
<p>MA 23 pístní</p> 	<p>Materiál: NBR 75 tlak: 8 MPa 5 MPa pracovní teplota -30+100°C spára(mm) 0,15 0,2</p> <p>Rychlost posuvu: max. 0,5 ms⁻¹ Vlastnosti: těsnění pístů pro hydrauliku a pneumatiku. Asymetrický tvar - vyšší vnitřní břit, umožňuje pevné zajištění a usazení manžety v drážce pístu. Českou obdobou tohoto těsnění je typ dle PN 029274. Pro vyšší tlaky použijte typ MA 28.</p> <p>Rozměry: standardní viz. rozměrová řada, ostatní na poptávku.</p>
<p>MA 24 pístnicové</p> 	<p>Materiál: NBR 90 tlak: 16 MPa 10 MPa 5 MPa pracovní teplota -30+100°C spára(mm) 0,1 0,15 0,2</p> <p>Rychlost posuvu: max. 0,5 ms⁻¹ Vlastnosti: těsnění pístnicové (pístní válec) pro hydrauliku. Asymetrický tvar - vyšší venkovní břit, umožňuje pevné zajištění a usazení manžety v drážce pístnice. Českou obdobou tohoto těsnění je typ dle ČSN 029275. Pro vyšší tlaky použijte typ MA 30.</p> <p>Rozměry: standardní viz. rozměrová řada, ostatní na poptávku.</p>
<p>MA 25 univerzální</p> 	<p>Materiál: PU 92 tlak: 30 MPa 20 MPa 10 MPa pracovní teplota -40+100°C spára(mm) 0,3 0,35 0,5</p> <p>Rychlost posuvu: max. 0,5 ms⁻¹ Vlastnosti: jeden z nejběžněji používaných typů. Univerzální drážkové symetrické manžety jsou určeny k utěsnění pístů a pístnic hydraulických zařízení. Symetrická geometrie profilu dovoluje použití manžet jako univerzálního těsnění. Polyurethan pak zajišťuje vysokou odolnost proti opotřebení. Českou obdobou tohoto těsnění je typ dle ČSN 029269.3.</p> <p>Rozměry: standardní viz. rozměrová řada, ostatní na poptávku.</p>
<p>MA 28 pístní</p> 	<p>Materiál: PU 92 tlak: 40 MPa 20 MPa 5 MPa teplota -40+100°C (+40v HFA,B,C) spára(mm) 0,25 0,35 0,6</p> <p>Rychlost posuvu: max. 0,5 ms⁻¹ Vlastnosti: těsnění pístů pro hydrauliku. Jeden z nejběžněji používaných typů. Asymetrický tvar - vyšší vnitřní břit, umožňuje pevné zajištění a usazení manžety v drážce pístu. Polyurethan pak zajišťuje vysokou odolnost proti opotřebení. Českou obdobou tohoto těsnění je typ dle PN 029274. S podobným těsněním je možné se setkat u firmy Merkel pod označením T 18.</p> <p>Rozměry: standardní viz. rozměrová řada, ostatní na poptávku.</p>

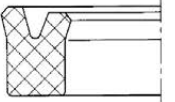
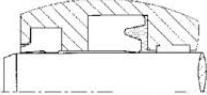
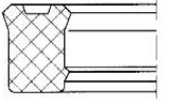

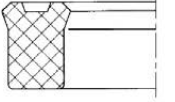
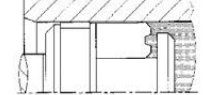
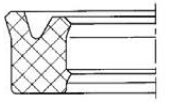
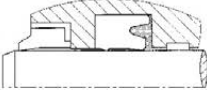
<p>MA 30 pístnicové</p>  	<p>Materiál: PU 92 tlak 40 MPa 20 MPa 5 MPa teplota -40+100°C (+40v HFA,B,C) spára(mm) 0,25 0,35 0,6</p> <p>Rychlost posuvu: max. 0,5 ms⁻¹</p> <p>Vlastnosti: těsnění pístnicové (pístní válec) pro hydrauliku. Jeden z nejběžněji používaných typů. Asymetrický tvar - vyšší venkovní břit, umožňuje pevné zajištění a usazení manžety v drážce pístnice. Polyurethan pak zajišťuje vysokou odolnost proti opotřebení. Českou obdobou tohoto těsnění je typ dle PN 029275. S podobným těsněním je možné se setkat u firmy Merkel pod označením T 20.</p> <p>Rozměry: standardní viz. rozměrová řada, ostatní na poptávku.</p>
<p>MA 35 pístnicové</p>  	<p>Materiál: PU 92 tlak 40 MPa 20 MPa 5 MPa teplota -40+100°C (+40v HFA,B,C) spára(mm) 0,25 0,35 0,6</p> <p>Rychlost posuvu: max. 0,5 ms⁻¹</p> <p>Vlastnosti: kompaktní pístnicové těsnění s druhým těsnícím břitem pro hydrauliku. Tento druhý břit, orientovaný ke kluzné ploše, podstatně stabilizuje faktor účinnosti. Také díky kompaktní stavbě těla manžety je zachována těsnící funkce při působení nízkého a nulového tlaku. Polyurethan pak zajišťuje vysokou odolnost proti opotřebení.</p> <p>Rozměry: standardní viz. rozměrová řada, ostatní na poptávku.</p>
<p>MA 36 pístnicové</p>  	<p>Materiál: PU 92 tlak: 40 MPa 20 MPa 5 MPa teplota -40+100°C (+40v HFA,B,C) spára(mm) 0,25 0,35 0,6</p> <p>Rychlost posuvu: max. 0,5 ms⁻¹</p> <p>Vlastnosti: kompaktní symetrické pístnicové těsnění pro hydrauliku. Díky kompaktní stavbě těla a stálému radiálnímu předpětí břitů je zachována těsnící funkce i při působení nízkého a nulového tlaku. Polyurethan pak zajišťuje vysokou odolnost proti opotřebení.</p> <p>Rozměry: standardní viz. rozměrová řada, ostatní na poptávku.</p>
<p>MA 39 pístnicové</p>  	<p>Materiál: PU 92 tlak 40 MPa 20 MPa 5 MPa teplota -40+100°C (+40v HFA,B,C) spára(mm) 0,25 0,35 0,6</p> <p>Rychlost posuvu: max. 0,5 ms⁻¹</p> <p>Vlastnosti: kompaktní asymetrické pístnicové těsnění s druhým těsnícím břitem pro hydrauliku. Tento druhý břit, orientovaný ke kluzné ploše, podstatně stabilizuje faktor účinnosti. Díky kompaktní stavbě těla manžety je zachována těsnící funkce při působení nízkého a nulového tlaku. Polyurethan pak zajišťuje vysokou odolnost proti opotřebení. Typ MA39 je určen pro použití tam, kde se předpokládá nejvyšší hranice zatížitelnosti.</p> <p>Rozměry: standardní viz. rozměrová řada, ostatní na poptávku.</p>

Pomůcka: 1 MPa = 10 BAR = 10 ATM

Vlastnosti materiálů Rubena

NBR

3158 tvrdost 76-85 Shore A, rozsah pracovních teplot 30 +80°C. Pryž je vhodná pro prostředí ropných produktů (benzín, petrolej, minerální oleje a jejich vodní emulze, mazací tuky), pro styk s rostlinnými a živočišnými tuky a vzduchem. Informativní skladovatelnost je 8 let od data výroby.

PU

8158 tvrdost 76-85 Shore A, rozsah pracovních teplot 30+80°C (emulze vody v oleji či oleje ve vodě pouze do +40°C). Pryž je vhodná pro velmi mechanicky namáhaná těsnění. Pryž je vhodná pro minerální hydraulické oleje, minerální motorové a převodové oleje, benziny, motorovou naftu, mazací tuky, alifatické uhlovodíky a vzduch. Informativní skladovatelnost 3 roky od data výroby.
 8159 tvrdost 85-95 Shore A. Ostatní parametry shodné s materiálem 8158.

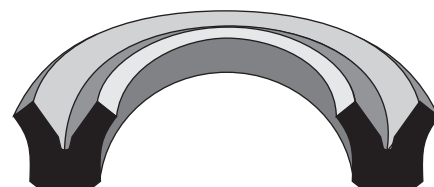

0 / 22 x 8

26 / 37 x 5

d	/ D	x h	typ ČSN 0292..	materiál
0	/ 22	x 8	70.3	3158
0	/ 24	x 9	70.3	3158
0	/ 38	x 8	70.3	3158
0	/ 40	x 12	70.3	3158
0	/ 45	x 9	70.3	3158
0	/ 60	x 14	70.3	3158
2	/ 8	x 6	70.3	3158
2	/ 12	x 8	70.3	3158
2	/ 14	x 8	70.3	3158
3	/ 10	x 6	70.3	3158
3	/ 16	x 8	70.3	3158
3	/ 18	x 8	70.3	3158
4,8	/ 10	x 6	70.3	3158
4	/ 9,5	x 3		3357
4	/ 12	x 4	68	3158
4	/ 14	x 10	70.3	3158
5	/ 10	x 3	68	3158
5	/ 12	x 4,5	60.3	3158
6	/ 14	x 5	60.3	3158
6	/ 14	x 7	70.3	3158
6	/ 20	x 10,5	60.3	3158
7	/ 15	x 5	60.3	3158
7	/ 15	x 6	60.3	3158
7	/ 50	x 12	70.3	3158
8	/ 14	x 4	68	3158
8	/ 15,5	x 5	brzd	33469
8	/ 16	x 5	60.3	3158
8	/ 18	x 5	68	3158
8	/ 20	x 7	60.3	3158
8	/ 20	x 10	70.3	3158
8	/ 22	x 10	70.3	3158
8	/ 25	x 10	70.3	3158
8	/ 28	x 10	70.3	3158
8	/ 30	x 10	70.3	3158
8	/ 35	x 10	70.3	3158
9,5	/ 25	x 10	70.3	3158
9,5	/ 25	x 8	70.3	3158
9,5	/ 55,5	x 9,5	70.3	3158
9,5	/ 56	x 12	70.3	3158
9	/ 17	x 5	60.3	3158
10	/ 16	x 4	60.3	3158
10	/ 17,5	x 5	brzd	33469
10	/ 18	x 4	69.1	3158
10	/ 18	x 4	69.3	8159
10	/ 18	x 5	60.3	3158
10	/ 20	x 5	68	3158
10	/ 20	x 5,5	70.3	3158
10	/ 25	x 10,5	60.3	3158
10	/ 30	x 12	60.3	3158
10	/ 40	x 10,5	70.3	3158
10	/ 42	x 12	70.3	3158
10	/ 69	x 11	70.3	3158
11	/ 19	x 6,5	60.3	3158
11	/ 19	x 6,6	brzd	33469
11	/ 20	x 5	brzd	33479
11	/ 22	x 7	60.3	3158
11	/ 22	x 7	65.3	3158
11	/ 27	x 9	60.3	3158
12	/ 18	x 4	68	3158
12	/ 20	x 4	69.1	3158
12	/ 20	x 4	69.3	8159
12	/ 24	x 6	68	3158
12	/ 24	x 10	70.3	3158
12	/ 25	x 7	60.3	3158
12	/ 25	x 7	65.3	3158
12	/ 26	x 8	60.3	3158
12	/ 26	x 10	60.3	3158
12	/ 28	x 10,5	60.3	3158
12	/ 32	x 10	60.3	3158

12	/ 32	x 10	70.3	3158
12	/ 36	x 12	70.3	3158
12	/ 39	x 8	70.3	3158
12	/ 40	x 12	70.3	3158
12	/ 45	x 12	70.3	3158
12	/ 55	x 12	70.3	3158
12	/ 56	x 12	70.3	3158
12	/ 60	x 12	70.3	3158
12	/ 72	x 12	70.3	3158
12	/ 75	x 12	70.3	3158
13,5	/ 21	x 4,5	60.3	3158
13	20	x 5	60.3	3158
13	/ 24	x 8	70.3	3158
13	/ 25	x 7	60.3	3158
13	/ 25	x 7	65.3	3158
13	/ 25	x 8	70.3	3158
13	/ 30	x 10,5	60.3	3158
13	/ 32	x 8,5	70.3	3158
13	/ 38	x 15	60.3	3158
13	/ 54	x 12	70.3	3158
14	/ 22	x 4	69.1	3158
14	/ 22	x 4	69.3	8159
14	/ 23	x 5	68	3158
14	/ 25	x 7	60.3	3158
14	/ 26	x 6	60.3	3158
14	/ 27	x 6	60.3	3158
14	/ 30	x 7	65.3	3158
14	/ 60	x 12	70.3	3158
14	/ 68	x 15	70.3	3158
14	/ 80	x 25	70.3	3158
15	/ 25	x 7	60.3	3158
15	/ 26	x 7	60.3	3158
15	/ 27	x 7	60.3	3158
15	/ 27	x 7	65.3	3158
15	/ 27	x 10	70.3	3158
15	/ 28	x 7	60.3	3158
15	/ 30	x 10	60.3	3158
15	/ 30	x 10,5	60.3	3158
15	/ 35	x 13	60.3	3158
15	/ 43	x 12	70.3	3158
15	/ 45	x 12	70.3	3158
15	/ 63	x 12	70.3	3158
16	/ 24	x 4	69.1	3158
16	/ 24	x 4	69.3	8159
16	/ 25	x 5	60.3	3158
16	/ 25	x 5	68	3158
16	/ 28	x 7	60.3	3158
16	/ 28	x 7	65.3	3158
16	/ 32	x 8	60.3	3158
16	/ 37	x 13	60.3	3158
16	/ 40	x 15	60.3	3158
16	/ 40	x 16	60.3	3158
16	/ 40	x 20	70.3	3158
16	/ 50	x 20	70.3	3158
16	/ 57	x 12	70.3	3158
17	/ 25	x 4	69.1	3158
17	/ 25	x 4	69.3	8159
17	/ 28	x 7	60.3	3158
17	/ 32	x 6	60.3	3158
17	/ 32	x 10	74.1	8158
17	/ 32	x 10	74.2	8159
17	/ 40	x 16	60.3	3158
17	/ 45	x 12	70.3	3158
18,2	/ 100	x 26	70.3	3158
18,3	/ 8,4	x 7	70.3	3158
18	/ 26	x 4	69.1	3158
18	/ 26	x 4	69.3	8159
18	/ 28	x 5	60.3	3158
18	/ 28	x 5	68	3158
18	/ 28	x 7	60.3	3158
18	/ 30	x 7	60.3	3158

18	/ 30	x 7	65.3	3158
18	/ 34	x 10,5	60.3	3158
18	/ 36	x 13	60.3	3158
18	/ 101	x 25	70.3	3158
19,5	/ 25,5	x 5	60.3	3158
19	/ 8	x 8	70.3	3158
19	/ 27	x 5	60.3	3158
20	/ 28	x 4	69.1	3158
20	/ 28	x 4	69.1	8159
20	/ 30	x 5	68	3158
20	/ 30	x 7	60.3	3158
20	/ 30	x 8	75.1	8158
20	/ 30	x 8	75.2	8159
20	/ 32	x 7	60.3	3158
20	/ 32	x 7	65.3	3158
20	/ 35	x 10,5	60.3	3158
20	/ 36	x 10,5	60.3	3158
20	/ 40	x 10	60.3	3158
20	/ 40	x 13	60.3	3158
20	/ 40	x 13	70.3	3158
20	/ 100	x 25	70.3	3158
22,6	/ 30,5	x 6	60.3	3158
22,8	/ 40	x 8	70.3	3158
22	/ 30	x 4	69.1	3158
22	/ 30	x 4	69.3	8159
22	/ 31	x 8	brzd	31469
22	/ 32	x 5	60.3	3158
22	/ 32	x 5	68	3158
22	/ 32	x 7	60.3	3158
22	/ 34	x 6	60.3	3158
22	/ 34	x 7	60.3	3158
22	/ 34	x 7	65.3	3158
22	/ 36	x 10,5	60.3	3158
22	/ 40	x 13	60.3	3158
22	/ 44	x 16	60.3	3158
22	/ 85	x 22	70.3	3158
23	/ 43	x 13	60.3	3158
24,5	/ 38	x 6,5	60.3	3158
24,5	/ 93	x 15	70.3	3158
24	/ 32	x 4	69.1	3158
24	/ 32	x 4	69.3	8159
24	/ 34	x 5	60.3	3158
24	/ 40	x 10,5	60.3	3158
24	/ 41	x 10,5	60.3	3158
25	/ 33	x 4	69.1	3158
25	/ 33	x 4	69.3	8159
25	/ 34	x 8	60.3	3158
25	/ 35	x 8	75.1	8158
25	/ 35	x 8	75.2	8159
25	/ 36	x 5	68	3158
25	/ 36	x 7	60.3	3158
25	/ 36	x 7	65.3	3158
25	/ 37	x 6,5	60.3	3158
25	/ 38	x 7	60.3	3158
25	/ 38	x 7	brzd	31469
25	/ 40	x 10	74.1	8158
25	/ 40	x 10	74.2	8159
25	/ 40	x 10,5	60.3	3158
25	/ 40	x 10,5	65.3	3158
25	/ 45	x 8	60.3	3158
25	/ 45	x 10	60.3	3158
25	/ 45	x 12	70.3	3158
25	/ 45	x 13	60.3	3158
25	/ 48	x 12	70.3	3158
25	/ 50	x 12	60.3	3158
25	/ 50	x 16	60.3	3158
26	/ 34	x 4	60.3	3158
26	/ 34	x 4	69.1	3158
26	/ 35	x 6	60.3	3158
26	/ 36	x 5	60.3	3158
26	/ 37	x 5	60.3	3158

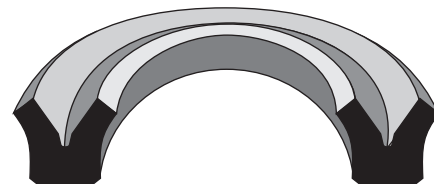

26 / 42 x 10

63 / 82 x 13

d / D	x h	typ ČSN 0292..	materiál
26 / 42	x 10,5	60.3	3158
26 / 50	x 16	60.3	3158
27 / 40	x 7	60.3	3158
27 / 50	x 12	70.3	3158
27 / 50	x 16	60.3	3158
28 / 34	x 6	60.3	3158
28 / 36	x 4	69.1	3158
28 / 36	x 4	69.3	8159
28 / 38	x 5	60.3	3158
28 / 38	x 5	68	3158
28 / 40	x 7	60.3	3158
28 / 44	x 10	60.3	3158
28 / 45	x 10,5	60.3	3158
28 / 45	x 10,5	65.3	3158
28 / 47	x 13	60.3	3158
28 / 48	x 13	60.3	3158
28 / 50	x 16	60.3	3158
28 / 52	x 16	60.3	3158
29,6 / 38,5	x 6	60.3	3158
29 / 38	x 5	60.3	3158
30 / 38	x 4	60.3	3158
30 / 38	x 4	69.2	8158
30 / 40	x 5	68	3158
30 / 40	x 7	60.3	3158
30 / 45	x 6	70.3	3158
30 / 45	x 10,5	60.3	3158
30 / 50	x 8	70.3	3158
30 / 50	x 10	60.3	3158
30 / 50	x 12	60.3	3158
30 / 50	x 13	60.3	3158
30 / 50	x 13	61	texpryž
30 / 55	x 12	60.3	3158
30 / 60	x 10	70.3	3158
30 / 60	x 12	70.3	3158
30 / 60	x 19	60.3	3158
31 / 45	x 6,5	60.3	3158
31 / 100	x 24	70.3	3158
32 / 40	x 4	69.1	3158
32 / 40	x 4	69.3	8159
32 / 40	x 7,5	60.3	3158
32 / 42	x 6	68	3158
32 / 47	x 10	75.1	8158
32 / 47	x 10	75.2	8159
32 / 48	x 10,5	60.3	3158
32 / 48	x 10,5	65.3	3158
32 / 52	x 10	60.3	3158
32 / 52	x 13	60.3	3158
32 / 54	x 10	60.3	3158
32 / 55	x 16	60.3	3158
32 / 65	x 12	70.3	3158
32 / 66	x 18	60.3	3158
33,5 / 45	x 7	60.3	3158
34,5 / 51	x 8	60.3	3158
34 / 49	x 8,5	60.3	3158
34 / 80	x 16	70.3	3158
35,5 / 50	x 10,5	60.3	3158
35 / 45	x 6	68	3158
35 / 45	x 7	60.3	3158
35 / 47	x 7	60.3	3158
35 / 50	x 6,5	65.3	3158
35 / 50	x 10	74.1	8158
35 / 50	x 10	74.2	8159
35 / 50	x 10,5	60.3	3158
35 / 50	x 10,5	65.3	3158
35 / 53	x 10	60.3	3158
35 / 55	x 13	60.3	3158
35 / 60	x 20	70.3	3158
35 / 70	x 12	70.3	3158
35 / 85	x 10	70.3	3158

35 / 110	x 16	70.3	3158
36 / 44	x 4	69.1	3158
36 / 44	x 4	69.3	8159
36 / 48	x 6	60.3	3158
36 / 48	x 7	60.3	3158
36 / 51	x 10	75.1	8158
36 / 51	x 10	75.2	8159
36 / 52	x 10,5	60.3	3158
36 / 52	x 10,5	65.3	3158
37 / 45	x 4	69.1	3158
37 / 45	x 4	69.3	8159
37 / 150	x 20	70.3	3158
38 / 51	x 9,5	60.3	3158
38 / 55	x 10,5	60.3	3158
39,5 / 105	x 16	70.3	3158
40 / 47,8	x 7	60.3	3158
40 / 50	x 5	69.1	3158
40 / 50	x 5	69.3	8159
40 / 50	x 6	68	3158
40 / 50	x 7	60.3	3158
40 / 55	x 10	75.1	8158
40 / 55	x 10	75.2	8159
40 / 56	x 6,5	65.3	3158
40 / 56	x 10,5	60.3	3158
40 / 56	x 10,5	65.3	3158
40 / 60	x 10,5	60.3	3158
40 / 60	x 13	60.3	3158
40 / 64	x 16	60.3	3158
40 / 65	x 8	70.3	3158
40 / 65	x 12	60.3	3158
40 / 65	x 14	60.3	3158
40 / 145	x 20	70.3	3158
41 / 51,5	x 7	60.3	3158
41 / 54	x 9,5	60.3	3158
42 / 58	x 10,5	60.3	3158
42 / 70	x 18	60.3	3158
42 / 72	x 19	60.3	3158
42 / 100	x 16	70.3	3158
43 / 63	x 12	74.1	8158
43 / 63	x 12	74.2	8159
44 / 56	x 8	60.3	3158
44 / 64	x 13	60.3	3158
45,2 / 78	x 12	70.3	3158
45 / 55	x 5	69.1	3158
45 / 55	x 5	69.3	8159
45 / 56	x 6	68	3158
45 / 56	x 7	60.3	3158
45 / 58	x 7	68	3158
45 / 60	x 10	75.1	8158
45 / 60	x 10	75.2	8159
45 / 60	x 10,5	60.3	3158
45 / 60	x 10,5	65.3	3158
45 / 63	x 13	60.3	3158
45 / 65	x 13	60.3	3158
45 / 70	x 13	60.3	3158
45 / 80	x 15	70.3	3158
46 / 63	x 8,5	60.3	3158
48 / 60	x 6	68	3158
48 / 60	x 7	60.3	3158
48 / 75	x 16	65.3	3158
50,4 / 60,4	x 8	60.3	3158
50 / 60	x 5	60.3	3158
50 / 60	x 5	69.1	3158
50 / 60	x 5	69.3	8159
50 / 60	x 7	60.3	3158
50 / 62	x 7	60.3	3158
50 / 62	x 9	60.3	3158
50 / 63	x 7	60.3	3158
50 / 63	x 7,5	68	3158
50 / 65	x 10	75.1	8158
50 / 65	x 10	75.2	8159

50 / 70	x 10	60.3	3158
50 / 70	x 12	60.3	3158
50 / 70	x 13	60.3	3158
50 / 70	x 13	65.3	3158
50 / 75	x 6	70.3	3158
50 / 75	x 12	60.3	3158
50 / 75	x 15	70.3	3158
50 / 80	x 19	60.3	3158
50 / 114	x 16	70.3	3158
51 / 66	x 7,5	60.3	3158
51 / 72	x 11	60.3	3158
52 / 62	x 5	60.3	3158
52 / 62	x 5	68	3158
52 / 62	x 9	60.3	3158
52 / 66	x 10,5	60.3	3158
52 / 72	x 13	60.3	3158
53 / 63	x 5	69.1	3158
63 / 63	x 5	69.3	8159
53 / 71	x 13	60.3	3158
55 / 65	x 5	69.1	3158
55 / 65	x 5	69.3	8159
55 / 69	x 9,5	60.3	3158
55 / 70	x 6	60.3	3158
55 / 70	x 7,5	68	3158
55 / 70	x 10	75.1	8158
55 / 70	x 10	75.2	8159
55 / 70	x 10,5	60.3	3158
55 / 75	x 10	60.3	3158
55 / 75	x 13	60.3	3158
55 / 80	x 12,5	60.3	3158
55 / 80	x 16	60.3	3158
55 / 80	x 16	65.3	3158
55 / 85	x 12	60.3	3158
55 / 85	x 15	60.3	3158
56 / 66	x 5	60.3	3158
56 / 66	x 5	69.1	3158
56 / 66	x 5	69.3	8159
56 / 71	x 7,5	60.3	3158
56 / 73	x 10	60.3	3158
56 / 75	x 13	60.3	3158
56 / 88	x 19	60.3	3158
58 / 68	x 7	60.3	3158
58 / 70	x 6	60.3	3158
58 / 78	x 13	60.3	3158
59 / 75	x 7	60.3	3158
60 / 70	x 5	69.1	3158
60 / 70	x 5	69.3	8159
60 / 70	x 20	60.3	3158
60 / 75	x 7,5	68	3158
60 / 80	x 12	74.1	8158
60 / 80	x 12	74.2	8159
60 / 80	x 13	60.3	3158
60 / 85	x 16	60.3	3158
60 / 90	x 7	70.3	3158
60 / 90	x 19	60.3	3158
60 / 92	x 19	65.3	3158
60 / 99	x 12	70.3	3158
60 / 125	x 15	70.3	3158
60 / 140	x 20	70.3	3158
62 / 75	x 6	60.3	3158
62 / 78	x 8	68	3158
62 / 78	x 10,5	60.3	3158
62 / 80	x 13	60.3	3158
62 / 82	x 13	60.3	3158
63 / 73	x 5	60.3	3158
63 / 73	x 5	69.1	3158
63 / 73	x 5	69.3	8159
63 / 78	x 10	75.1	8158
63 / 78	x 10	75.2	8159
63 / 82	x 13	60.3	3158
63 / 82	x 13	65.3	3158

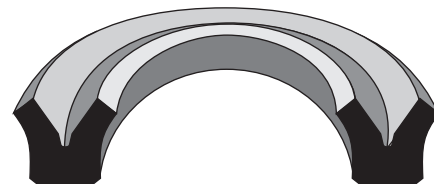

63 / 95 x 19

160 / 200 x 10

d / D	x h	typ ČSN 0292..	materiál
63 / 95	x 19	60.3	3158
65,5 / 80	x 10	60.3	3158
65 / 75	x 5	60.3	3158
65 / 75	x 14	60.3	3158
65 / 80	x 7,5	60.3	3158
65 / 80	x 7,5	68	3158
65 / 80	x 10,5	60.3	3158
65 / 85	x 13	60.3	3158
65 / 90	x 16	60.3	3158
65 / 95	x 19	60.3	3158
68 / 78	x 8	60.3	3158
68 / 92	x 16	60.3	3158
70 / 80	x 5	60.3	3158
70 / 80	x 5	69.1	3158
70 / 80	x 5	69.3	8159
70 / 80	x 8	60.3	3158
70 / 81,5	x 10	60.3	3158
70 / 85	x 7,5	68	3158
70 / 85	x 10	75.1	8158
70 / 85	x 10	75.2	8159
70 / 85	x 10,5	60.3	3158
70 / 90	x 12	74.1	8158
70 / 90	x 12	74.2	8159
70 / 90	x 13	60.3	3158
70 / 95	x 16	60.3	3158
70 / 100	x 19	60.3	3158
70 / 110	x 15	70.3	3158
70 / 117	x 16	70.3	3158
70 / 120	x 16	70.3	3158
70 / 120	x 30	60.3	3158
75 / 85	x 5	60.3	3158
75 / 85	x 8	60.3	3158
75 / 90	x 7,5	68	3158
75 / 90	x 10,5	60.3	3158
75 / 92	x 9,5	60.3	3158
75 / 95	x 13	60.3	3158
75 / 100	x 16	60.3	3158
75 / 105	x 15	60.3	3158
75 / 125	x 15	70.3	3158
77,5 / 90	x 7	60.3	3158
80 / 90	x 5	69.1	3158
80 / 90	x 5	69.3	8159
80 / 90	x 20	60.3	3158
80 / 100	x 10	69.1	3158
80 / 100	x 10	69.3	8159
80 / 100	x 12	74.1	8158
80 / 100	x 12	74.2	8159
80 / 100	x 12	75.1	8158
80 / 100	x 12	75.2	8159
80 / 100	x 13	60.3	3158
80 / 100	x 14	60.3	3158
80 / 105	x 16	60.3	3158
80 / 110	x 19	60.3	3158
80 / 115	x 20	60.3	3158
80 / 150	x 20	70.3	3158
81 / 98	x 10	60.3	3158
82 / 92	x 10	60.3	3158
82 / 103	x 11	60.3	3158
82 / 208	x 25	70.3	3158
85 / 95	x 8	60.3	3158
85 / 95	x 14	60.3	3158
85 / 100	x 7,5	68	3158
85 / 100	x 9	60.3	3158
85 / 100	x 10,5	60.3	3158
85 / 105	x 20	60.3	3158
85 / 107	x 13	60.3	3158
85 / 110	x 16	60.3	3158
85 / 120	x 15	70.3	3158
86 / 100	x 10	60.3	3158

90 / 99	x 14	60.3	3158
90 / 100	x 5	69.1	3158
90 / 100	x 5	69.3	8159
90 / 100	x 10	69.1	3158
90 / 100	x 10	69.3	8159
90 / 100	x 14	60.3	3158
90 / 105	x 7,5	60.3	3158
90 / 110	x 10	69.1	3158
90 / 110	x 10	69.3	8159
90 / 110	x 12	74.1	8158
90 / 110	x 12	74.2	8159
90 / 110	x 12	75.1	8158
90 / 110	x 12	75.2	8159
90 / 110	x 13	60.3	3158
90 / 115	x 16	60.3	3158
90 / 120	x 15	60.3	3158
90 / 140	x 15	70.3	3158
92 / 112	x 9,5	60.3	3158
93 / 117	x 15	60.3	3158
95 / 110	x 10,5	60.3	3158
95 / 115	x 13	60.3	3158
95 / 120	x 16	60.3	3158
98 / 120	x 20	60.3	3158
100 / 110	x 5	69.1	3158
100 / 110	x 5	69.3	8159
100 / 110	x 7	60.3	3158
100 / 110	x 15	60.3	3158
100 / 120	x 10	69.1	3158
100 / 120	x 10	69.3	8159
100 / 120	x 12	75.1	8158
100 / 120	x 12	75.2	8159
100 / 120	x 13	60.3	3158
100 / 125	x 16	60.3	3158
100 / 125	x 16	65.3	3158
100 / 140	x 24	60.3	3158
100 / 160	x 15	70.3	3158
100 / 200	x 25	70.3	3158
104 / 122	x 9,5	60.3	3158
105 / 125	x 10	69.1	3158
105 / 125	x 10	69.3	8159
105 / 125	x 15	74.1	8158
105 / 125	x 15	74.2	8159
105 / 135	x 19	60.3	3158
110 / 120	x 7	60.3	3158
110 / 120	x 14	60.3	3158
110 / 122	x 7	60.3	3158
110 / 125	x 7,5	68	3158
110 / 125	x 10,5	60.3	3158
110 / 130	x 10	69.1	3158
110 / 130	x 10	69.3	8159
110 / 130	x 12	75.1	8158
110 / 130	x 12	75.2	8159
110 / 130	x 13	60.3	3158
110 / 135	x 16	60.3	3158
110 / 140	x 19	60.3	3158
110 / 140	x 20	60.3	3158
110 / 140	x 20	70.3	3158
110 / 152	x 17	70.3	3158
110 / 210	x 25	70.3	3158
110 / 230	x 30	70.3	3158
115 / 140	x 15	65.3	3158
115 / 140	x 16	60.3	3158
115 / 145	x 15	65.3	3158
115 / 145	x 19	60.3	3158
120 / 130	x 5	60.3	3158
120 / 130	x 5	69.3	8159
120 / 130	x 10	60.3	3158
120 / 135	x 10,5	60.3	3158
120 / 140	x 10	68	3158
120 / 140	x 10	69.1	3158
120 / 140	x 10	69.3	8159

120 / 140	x 13	60.3	3158
120 / 140	x 15	74.1	8158
120 / 140	x 15	74.2	8159
120 / 150	x 8	70.3	8158
120 / 150	x 19	60.3	3158
120 / 150	x 19	65.3	3158
120 / 150	x 20	70.3	3158
120 / 160	x 35 M2	70.3	3158
125 / 145	x 10	69.1	3158
125 / 145	x 10	69.3	8159
125 / 145	x 12	75.1	8158
125 / 145	x 12	75.2	8159
125 / 145	x 13	60.3	3158
125 / 155	x 19	60.3	3158
125 / 160	x 22	60.3	3158
125 / 215	x 32	70.3	3158
128 / 144	x 13	60.3	3158
130 / 140	x 14	60.3	3158
130 / 150	x 13	60.3	3158
130 / 155	x 16	60.3	3158
130 / 160	x 15	60.3	3158
130 / 160	x 19	60.3	3158
130 / 161	x 19	60.3	3158
130 / 182	x 24	70.3	3158
130 / 200	x 20	70.3	3158
130 / 180	x 40 M2	70.3	3158
131 / 210	x 19	70.3	3158
133 / 145	x 6,5	60.3	3158
135 / 165	x 20	60.3	3158
135 / 170	x 22	60.3	3158
138 / 170	x 19	60.3	3158
140 / 150	x 5	60.3	3158
140 / 150	x 5	69.3	8159
140 / 160	x 10	68	3158
140 / 160	x 10	69.1	3158
140 / 160	x 10	69.3	8159
140 / 160	x 15	74.1	8158
140 / 160	x 15	74.2	8159
140 / 170	x 18	75.1	8158
140 / 170	x 18	75.2	8159
140 / 170	x 19	60.3	3158
140 / 175	x 20	60.3	3158
140 / 180	x 15	70.3	3158
140 / 200	x 22	70.3	3158
145 / 180	x 22	60.3	3158
146 / 279	x 25	70.3	3158
150 / 160	x 14	60.3	3158
150 / 170	x 9,5	60.3	3158
150 / 175	x 16	60.3	3158
150 / 180	x 15	60.3	3158
150 / 180	x 19	60.3	3158
150 / 190	x 20	60.3	3158
150 / 250	x 24	70.3	3158
150 / 260	x 30	70.3	3158
150 / 200	x 40 M2	70.3	3158
154 / 175	x 12,5	60.3	3158
155 / 180	x 16	60.3	3158
155 / 185	x 19	60.3	3158
158 / 202	x 20	60.3	3158
160 / 170	x 5	60.3	3158
160 / 170	x 5	69.3	8159
160 / 175	x 7,5	69.3	8159
160 / 180	x 10	69.1	3158
160 / 180	x 10	69.3	8159
160 / 180	x 15	74.1	8158
160 / 180	x 15	74.2	8159
160 / 180	x 18	60.3	3158
160 / 190	x 18	75.1	8158
160 / 190	x 18	75.2	8159
160 / 190	x 19	60.3	3158
160 / 200	x 10	70.3	3158

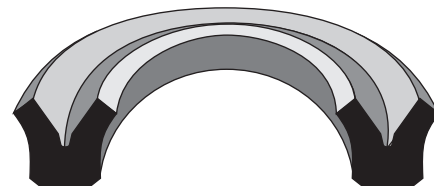

160 / 200 x 24

d / D x h	typ ČSN 0292..	materiál
160 / 200 x 24	60.3	3158
160 / 220 x 25	70.3	3158
165 / 200 x 22	60.3	3158
168 / 200 x 19	60.3	3158
170 / 195 x 16	60.3	3158
170 / 200 x 20	60.3	3158
170 / 203 x 20	60.3	3158
170 / 210 x 20	60.3	3158
170 / 250 x 20	70.3	3158
170 / 220 x 40 M2	70.3	3158
175 / 205 x 19	60.3	3158
175 / 225 x 40 M2	70.3	3158
180 / 200 x 10	68	3158
180 / 200 x 10	69.1	3158
180 / 200 x 10	69.3	8159
180 / 200 x 15	74.1	8158
180 / 200 x 15	74.2	8159
180 / 205 x 16	60.3	3158
180 / 210 x 18	75.1	8158
180 / 210 x 18	75.2	8159
180 / 210 x 19	60.3	3158
180 / 215 x 22	60.3	3158
180 / 215 x 23	60.3	3158
180 / 220 x 24	60.3	3158
180 / 220 x 25	60.3	3158
185 / 200 x 7,5	69.3	8159

460 / 500 x 27

190 / 220 x 18	74.1	8158
190 / 220 x 18	74.2	8159
190 / 220 x 19	60.3	3158
194 / 214 x 13	60.3	3158
194 / 216 x 15	70.3	3158
200 / 220 x 10	69.1	3158
200 / 220 x 10	69.3	8159
200 / 220 x 13	60.3	3158
200 / 230 x 19	60.3	3158
200 / 250 x 40 M2	70.3	3158
210 / 240 x 20	60.3	3158
210 / 250 x 25	60.3	3158
219 / 241 x 21	60.3	3158
220 / 250 x 18	74.1	8158
220 / 250 x 18	74.2	8159
220 / 250 x 19	60.3	3158
220 / 255 x 22	60.3	3158
220 / 260 x 20	60.3	3158
220 / 260 x 24	60.3	3158
225 / 250 x 20	60.3	3158
225 / 300 x 11	70.3	3158
230 / 250 x 10	68	3158
230 / 280 x 40 M2	70.3	3158
234 / 266 x 19	60.3	3158
240 / 270 x 20	60.3	3158
240 / 270 x 40	60.3	3158
240 / 280 x 20	60.3	3158
240 / 302 x 23	70.3	3158

248 / 302 x 25	70.3	3158
250 / 280 x 19	60.3	3158
260 / 290 x 19	60.3	3158
260 / 300 x 25	60.3	3158
265 / 305 x 24	60.3	3158
265 / 315 x 40 M2	70.3	3158
268 / 331 x 25	70.3	3158
270 / 315 x 30	60.3	3158
275 / 315 x 20	60.3	3158
280 / 320 x 20	60.3	3158
295 / 315 x 10	68	3158
295 / 325 x 19	60.3	3158
300 / 340 x 25	60.3	3158
310 / 350 x 25	60.3	3158
315 / 343 x 20	60.3	3158
323,6 / 355 x 15	60.3	3158
330 / 370 x 21	60.3	3158
360 / 400 x 22	60.3	3158
360 / 400 x 25	60.3	3158
360 / 408 x 20	60.3	3158
370 / 394 x 15	60.3	3158
370 / 400 x 20	60.3	3158
380 / 480 x 40	60.3	3158
400 / 430 x 19	60.3	3158
417 / 445 x 20	60.3	3158
420 / 460 x 20	60.3	3158
440 / 480 x 27	60.3	3158
460 / 500 x 27	60.3	3158

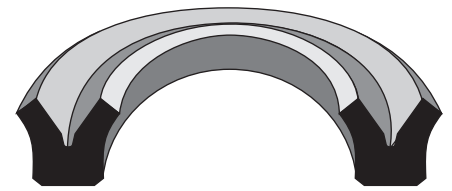

3 / 9 x 3				14 / 20 x 5							
d	/ D	x h	typ								
3,17	/ 9,52	x 3,96	MA 23	8	/ 15	x 5,7	MA 25	10	/ 25	x 10	MA 22
3	/ 9	x 4,5	MA 25	8	/ 15	x 6	MA 21	10	/ 26	x 8	MA 21
3	/ 10	x 5	MA 25	8	/ 15	x 6	MA 22	10	/ 26	x 8	MA 22
4,5	/ 11	x 5	MA 25	8	/ 15	x 8	MA 25	10	/ 26	x 9,5	MA 21
4,5	/ 12,5	x 4,5	MA 25	8	/ 16	x 5,5	MA 24	10	/ 28	x 10	MA 21
4,76	/ 11,11	x 3,96	MA 23	8	/ 16	x 5,5	MA 39	10	/ 30	x 10	MA 21
4	/ 7,5	x 3	MA 21	8	/ 16	x 5,7	MA 25	10	/ 30	x 10	MA 22
4	/ 9	x 3,5	MA 24	8	/ 16	x 5,7	MA 28	10	/ 32	x 6	MA 22
4	/ 10	x 4	MA 22	8	/ 16	x 5,7	MA 30	11,11	/ 19,09	x 3,96	MA 24
4	/ 10	x 4	MA 25	8	/ 16	x 5,7	MA 36	11,5	/ 21,5	x 7	MA 21
4	/ 10	x 5	MA 21	8	/ 16	x 5,8	MA 35	11	/ 17	x 3,2	MA 22
4	/ 11	x 8	MA 21	8	/ 16	x 6	MA 21	12,05	/ 17,46	x 3,17	MA 23
4	/ 11	x 8	MA 22	8	/ 16	x 6	MA 22	12,6	/ 17,5	x 6,5	MA 22
4	/ 12	x 4	MA 21	8	/ 16	x 6	MA 25	12,7	/ 19,05	x 3,17	MA 23
4	/ 12	x 4	MA 22	8	/ 16	x 8	MA 21	12,7	/ 19	x 5	MA 21
4	/ 12	x 4	MA 22	8	/ 16	x 8	MA 22	12	/ 18	x 4	MA 21
4	/ 12	x 5,5	MA 21	8	/ 16	x 8	MA 22	12	/ 18	x 4	MA 22
5	/ 11	x 5	MA 21	8	/ 18	x 6	MA 21	12	/ 18	x 4,5	MA 24
5	/ 11	x 5	MA 22	8	/ 18	x 8	MA 21	12	/ 18	x 4,5	MA 36
5	/ 11	x 7	MA 21	8	/ 18	x 8	MA 30	12	/ 18	x 5	MA 21
5	/ 12	x 5	MA 21	8	/ 18	x 9	MA 25	12	/ 18	x 5	MA 22
5	/ 12	x 5	MA 22	8	/ 22	x 8	MA 21	12	/ 18	x 5	MA 25
5	/ 12	x 5	MA 25	8	/ 22	x 8	MA 22	12	/ 18	x 6	MA 21
5	/ 12	x 5,5	MA 28	8	/ 22	x 8	MA 25	12	/ 18	x 6	MA 25
5	/ 12	x 6	MA 25	8	/ 25	x 6	MA 21	12	/ 20	x 5	MA 21
6,35	/ 12,7	x 3,96	MA 24	8	/ 25	x 6	MA 22	12	/ 20	x 5,5	MA 22
6	/ 10	x 3	MA 21	9,52	/ 16,5	x 3,96	MA 24	12	/ 20	x 5,5	MA 23
6	/ 12	x 4	MA 22	9	/ 15	x 8	MA 25	12	/ 20	x 5,5	MA 24
6	/ 12	x 4	MA 24	9	/ 15	x 9	MA 24	12	/ 20	x 5,5	MA 28
6	/ 12	x 4	MA 25	9	/ 19	x 6	MA 25	12	/ 20	x 5,5	MA 36
6	/ 12	x 4,5	MA 25	10	/ 14	x 2,5	MA 22	12	/ 20	x 5,7	MA 30
6	/ 12	x 5	MA 25	10	/ 15	x 5	MA 22	12	/ 20	x 5,7	MA 36
6	/ 12	x 5,5	MA 25	10	/ 16	x 4	MA 21	12	/ 20	x 5,8	MA 35
6	/ 12	x 6	MA 21	10	/ 16	x 4	MA 22	12	/ 20	x 7	MA 25
6	/ 12	x 6	MA 22	10	/ 16	x 4	MA 23	12	/ 20	x 8	MA 21
6	/ 12	x 6	MA 25	10	/ 16	x 4	MA 25	12	/ 20	x 8	MA 25
6	/ 12	x 7	MA 21	10	/ 16	x 4,5	MA 30	12	/ 22	x 5	MA 21
6	/ 12	x 8	MA 22	10	/ 16	x 5	MA 21	12	/ 22	x 5	MA 25
6	/ 13	x 5	MA 30	10	/ 16	x 5	MA 22	12	/ 22	x 6	MA 21
6	/ 14	x 5,7	MA 30	10	/ 16	x 6	MA 21	12	/ 22	x 6	MA 22
6	/ 14	x 5,7	MA 36	10	/ 16	x 6	MA 25	12	/ 22	x 7	MA 21
6	/ 14	x 5,8	MA 35	10	/ 16	x 6	MA 28	12	/ 22	x 7	MA 25
6	/ 15	x 5	MA 21	10	/ 16	x 8	MA 28	12	/ 22	x 7,2	MA 30
6	/ 15	x 5	MA 22	10	/ 18	x 5	MA 22	12	/ 22	x 8	MA 21
6	/ 15	x 6	MA 22	10	/ 18	x 5,5	MA 24	12	/ 22	x 8	MA 25
6	/ 15	x 8	MA 25	10	/ 18	x 5,5	MA 25	12	/ 22	x 8	MA 28
6	/ 16	x 5	MA 22	10	/ 18	x 5,5	MA 36	12	/ 22	x 8	MA 30
6	/ 16	x 6	MA 21	10	/ 18	x 5,5	MA 39	12	/ 24	x 6	MA 21
6	/ 16	x 6	MA 22	10	/ 18	x 5,7	MA 30	12	/ 24	x 6	MA 22
6	/ 16	x 8	MA 28	10	/ 18	x 5,7	MA 36	12	/ 24	x 8	MA 25
6	/ 17	x 6	MA 21	10	/ 18	x 5,8	MA 35	12	/ 24	x 9	MA 25
6	/ 17	x 6	MA 22	10	/ 18	x 6	MA 21	12	/ 24	x 10	MA 21
6	/ 18	x 8	MA 21	10	/ 18	x 6	MA 25	12	/ 24	x 10	MA 22
6	/ 18	x 8	MA 22	10	/ 18	x 8	MA 21	12	/ 25	x 8	MA 22
6	/ 20	x 8	MA 21	10	/ 18	x 8	MA 25	12	/ 25	x 8	MA 25
6	20	x 8	MA 22	10	/ 20	x 5	MA 21	12	/ 25	x 10	MA 25
7,93	/ 14,28	x 4,76	MA 23	10	/ 20	x 7	MA 21	12	/ 26	x 8	MA 22
7,93	/ 15,87	x 5,5	MA 23	10	/ 20	x 7,2	MA 30	12	/ 26	x 10	MA 21
7	/ 14	x 3,5	MA 22	10	/ 20	x 7,5	MA 28	12	/ 26	x 10	MA 22
7	/ 15	x 5	MA 22	10	/ 20	x 8	MA 21	12	/ 28	x 10	MA 21
7	/ 15	x 7	MA 25	10	/ 20	x 8	MA 22	12	/ 28	x 10	MA 22
8	/ 12	x 4	MA 22	10	/ 20	x 8	MA 25	12	/ 32	x 10	MA 22
8	/ 12	x 5	MA 21	10	/ 20	x 8	MA 28	12	/ 35	x 12	MA 21
8	/ 13	x 5	MA 22	10	/ 22	x 6	MA 22	12	/ 35	x 12	MA 22
8	/ 14	x 4	MA 21	10	/ 22	x 6	MA 25	13	/ 30	x 10	MA 21
8	/ 14	x 4	MA 22	10	/ 22	x 8	MA 21	13	/ 30	x 10	MA 22
8	/ 14	x 4	MA 24	10	/ 22	x 8	MA 22	14,28	/ 20,63	x 4,76	MA 24
8	/ 14	x 4,5	MA 28	10	/ 22	x 8	MA 25	14,28	/ 20,63	x 6,35	MA 23
8	/ 14	x 6	MA 21	10	/ 22	x 9	MA 21	14	/ 20	x 4	MA 22
8	/ 14	x 6	MA 25	10	/ 22	x 9	MA 22	14	/ 20	x 4,8	MA 25
8	/ 14	x 6,3	MA 28	10	/ 25	x 10	MA 21	14	/ 20	x 5	MA 21

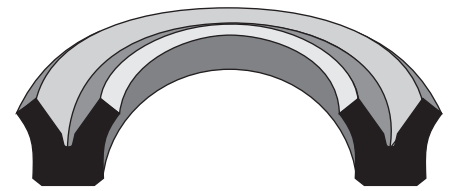

14 / 20 x 6				20 / 40 x 10			
d	/ D	x h	typ				
14	/ 20	x 6	MA 21	16	/ 24	x 5,7	MA 30
14	/ 22	x 4	MA 22	16	/ 24	x 5,7	MA 36
14	/ 22	x 5	MA 21	16	/ 24	x 5,8	MA 35
14	/ 22	x 5,5	MA 24	16	/ 24	x 6	MA 21
14	/ 22	x 5,5	MA 36	16	/ 24	x 6	MA 36
14	/ 22	x 5,5	MA 39	16	/ 24	x 9	MA 25
14	/ 22	x 5,7	MA 30	16	/ 25	x 5	MA 21
14	/ 22	x 5,7	MA 36	16	/ 25	x 5	MA 22
14	/ 22	x 5,8	MA 35	16	/ 26	x 5	MA 25
14	/ 22	x 6	MA 25	16	/ 26	x 6	MA 21
14	/ 22	x 8	MA 21	16	/ 26	x 6	MA 22
14	/ 22	x 8	MA 25	16	/ 26	x 7	MA 24
14	/ 22	x 11	MA 25	16	/ 26	x 7,2	MA 30
14	/ 22	x 12	MA 21	16	/ 26	x 8	MA 21
14	/ 24	x 6	MA 21	16	/ 26	x 8	MA 25
14	/ 24	x 6	MA 22	16	/ 26	x 8	MA 30
14	/ 24	x 7,2	MA 30	16	/ 26	x 8	MA 39
14	/ 24	x 8	MA 21	16	/ 26	x 8	MA 39
14	/ 24	x 8	MA 25	16	/ 26	x 9	MA 30
14	/ 24	x 8	MA 30	16	/ 26	x 10	MA 25
14	/ 26	x 8	MA 25	16	/ 28	x 6	MA 22
14	/ 28	x 7	MA 21	16	/ 28	x 6	MA 25
14	/ 28	x 7	MA 22	16	/ 28	x 6	MA 25
14	/ 28	x 10	MA 21	16	/ 28	x 9	MA 22
14	/ 28	x 10	MA 22	16	/ 29	x 6	MA 22
14	/ 32	x 8	MA 21	16	/ 32	x 8	MA 21
14	/ 32	x 10	MA 21	16	/ 32	x 8	MA 22
14	/ 32	x 10	MA 22	16	/ 32	x 8	MA 22
15,87	/ 22,22	x 4,76	MA 24	16	/ 32	x 8	MA 25
15,87	/ 25,4	x 6,35	MA 23	16	/ 32	x 8	MA 25
15	/ 20	x 3	MA 21	16	/ 32	x 10	MA 22
15	/ 20	x 3	MA 22	16	/ 32	x 10	MA 22
15	/ 22	x 4	MA 21	16	/ 36	x 10	MA 21
15	/ 22	x 4	MA 22	16	/ 36	x 10	MA 22
15	/ 23,5	x 8	MA 28	16	/ 36	x 10	MA 22
15	/ 24	x 7	MA 22	17,46	/ 23,81	x 4,76	MA 24
15	/ 25	x 5	MA 21	17,46	/ 26,99	x 6,35	MA 23
15	/ 25	x 5	MA 22	17,46	/ 30,16	x 7,93	MA 23
15	/ 25	x 5	MA 22	17	/ 25	x 5,5	MA 23
15	/ 25	x 6	MA 21	17	/ 25	x 5,5	MA 28
15	/ 25	x 6	MA 22	17	/ 25	x 10	MA 25
15	/ 25	x 6,3	MA 28	17	/ 32	x 10	MA 28
15	/ 25	x 8	MA 21	17	/ 38	x 10	MA 21
15	/ 25	x 8	MA 25	17	/ 38	x 10	MA 22
15	/ 25	x 8	MA 28	18	/ 24	x 4	MA 22
15	/ 25	x 8	MA 30	18	/ 25	x 4	MA 22
15	/ 25	x 10	MA 25	18	/ 25	x 4,5	MA 24
15	/ 27	x 6	MA 25	18	/ 25	x 5	MA 21
15	/ 28	x 8	MA 21	18	/ 25	x 5	MA 22
15	/ 28	x 10	MA 21	18	/ 25	x 5	MA 25
15	/ 28	x 10	MA 22	18	/ 25	x 5	MA 36
15	/ 28	x 10	MA 25	18	/ 25	x 5,5	MA 21
15	/ 30	x 6	MA 21	18	/ 25	x 6	MA 25
15	/ 30	x 8	MA 21	18	/ 26	x 4	MA 22
15	/ 30	x 8	MA 22	18	/ 26	x 5,7	MA 30
15	/ 30	x 10	MA 21	18	/ 26	x 5,7	MA 30
15	/ 30	x 10	MA 22	18	/ 26	x 5,8	MA 35
15	/ 30	x 10	MA 28	18	/ 26	x 6	MA 36
15	/ 35	x 10	MA 21	18	/ 26	x 6,5	MA 25
15	/ 35	x 10	MA 22	18	/ 26	x 8	MA 25
16	/ 22	x 3	MA 21	18	/ 26	x 8	MA 30
16	/ 22	x 4	MA 25	18	/ 26	x 8,5	MA 25
16	/ 22	x 5	MA 21	18	/ 28	x 5,8	MA 36
16	/ 22	x 5	MA 30	18	/ 28	x 6	MA 21
16	/ 22	x 6	MA 21	18	/ 28	x 6	MA 22
16	/ 22	x 6	MA 22	18	/ 28	x 6	MA 22
16	/ 24	x 4	MA 21	18	/ 28	x 7,2	MA 30
16	/ 24	x 5	MA 25	18	/ 28	x 8	MA 21
16	/ 24	x 5,5	MA 24	18	/ 28	x 8	MA 25
16	/ 24	x 5,5	MA 39	18	/ 30	x 6	MA 21
16	/ 24	x 5,7	MA 28	18	/ 30	x 6,5	MA 25
				18	/ 30	x 7,5	MA 21
				18	/ 30	x 8	MA 25
				18	/ 30	x 8	MA 30
				18	/ 30	x 8	MA 30
				18	/ 30	x 8	MA 35
				18	/ 30	x 8	MA 36
				18	/ 30	x 10	MA 21
				18	/ 30	x 10	MA 22
				18	/ 30	x 10	MA 25
				18	/ 30	x 10	MA 25
				18	/ 30	x 10	MA 30
				18	/ 30	x 10	MA 30
				18	/ 30	x 10	MA 36
				18	/ 32	x 6	MA 24
				18	/ 32	x 7,5	MA 21
				18	/ 32	x 7,5	MA 22
				18	/ 32	x 7,5	MA 22
				18	/ 32	x 7,5	MA 25
				18	/ 32	x 8	MA 25
				18	/ 32	x 8	MA 25
				18	/ 33	x 6	MA 21
				18	/ 35	x 10	MA 21
				18	/ 35	x 10	MA 22
				18	/ 35	x 10	MA 25
				18	/ 35	x 10	MA 25
				18	/ 35	x 10	MA 39
				18	/ 35	x 12	MA 25
				18	/ 36	x 8	MA 21
				18	/ 36	x 8	MA 22
				18	/ 38	x 8,5	MA 22
				18	/ 40	x 5	MA 21
				18	/ 40	x 10	MA 21

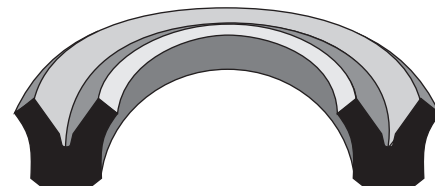

20 / 40 x 10				32 / 40 x 8			
d	/ D	x h	typ				
20	/ 40	x 10	MA 22	24	/ 32	x 7	MA 21
20	/ 40	x 10	MA 25	24	/ 32	x 7	MA 25
20	/ 40	x 12	MA 21	24	/ 34	x 5	MA 21
20	/ 40	x 12	MA 22	24	/ 40	x 8	MA 21
20	/ 43	x 12	MA 21	24	/ 40	x 8	MA 25
20	/ 43	x 12	MA 22	24	/ 40	x 10	MA 21
20	/ 43	x 12	MA 22	24	/ 40	x 10	MA 22
20	/ 45	x 12	MA 21	25,4	/ 38,1	x 6,35	MA 24
21	/ 37	x 12	MA 25	25,4	/ 38,1	x 7,93	MA 23
22,22	/ 31,75	x 4,76	MA 24	25	/ 32	x 4	MA 25
22,22	/ 34,92	x 6,35	MA 23	25	/ 32	x 4	MA 36
22	/ 28	x 4,5	MA 36	25	/ 33	x 4	MA 21
22	/ 28	x 5	MA 21	25	/ 33	x 4	MA 25
22	/ 28	x 5	MA 22	25	/ 33	x 5	MA 21
22	/ 28	x 6	MA 22	25	/ 33	x 5,7	MA 30
22	/ 28	x 8	MA 25	25	/ 33	x 5,8	MA 35
22	/ 29	x 5	MA 36	25	/ 33	x 5,8	MA 35
22	/ 30	x 4	MA 25	25	/ 33	x 6	MA 36
22	/ 30	x 5,5	MA 24	25	/ 33	x 6,5	MA 39
22	/ 30	x 5,7	MA 30	25	/ 33	x 7	MA 21
22	/ 30	x 5,7	MA 36	25	/ 33	x 7,2	MA 30
22	/ 30	x 5,8	MA 35	25	/ 33	x 8	MA 36
22	/ 30	x 6	MA 21	25	/ 33	x 10	MA 30
22	/ 30	x 6	MA 22	25	/ 35	x 5	MA 21
22	/ 30	x 6	MA 25	25	/ 35	x 5	MA 22
22	/ 30	x 6	MA 36	25	/ 35	x 5	MA 25
22	/ 30	x 6	MA 39	25	/ 35	x 5	MA 36
22	/ 30	x 6,5	MA 28	25	/ 35	x 5,8	MA 35
22	/ 30	x 7	MA 24	25	/ 35	x 6	MA 21
22	/ 30	x 7	MA 30	25	/ 35	x 6	MA 22
22	/ 30	x 7	MA 36	25	/ 35	x 6	MA 24
22	/ 30	x 8	MA 30	25	/ 35	x 6,5	MA 23
22	/ 30	x 10	MA 25	25	/ 35	x 7	MA 21
22	/ 32	x 5	MA 22	25	/ 35	x 7	MA 23
22	/ 32	x 6	MA 21	25	/ 35	x 7	MA 35
22	/ 32	x 6	MA 22	25	/ 35	x 7	MA 36
22	/ 32	x 7	MA 21	25	/ 35	x 7,2	MA 30
22	/ 32	x 7	MA 36	25	/ 35	x 7,3	MA 28
22	/ 32	x 7,2	MA 30	25	/ 35	x 8	MA 21
22	/ 32	x 7,3	MA 28	25	/ 35	x 8	MA 22
22	/ 32	x 8	MA 21	25	/ 35	x 8	MA 25
22	/ 32	x 8	MA 25	25	/ 35	x 8	MA 30
22	/ 32	x 8	MA 30	25	/ 35	x 8	MA 36
22	/ 32	x 8	MA 36	25	/ 35	x 9	MA 36
22	/ 32	x 10	MA 25	25	/ 35	x 10	MA 25
22	/ 32	x 10	MA 28	25	/ 35	x 10	MA 30
22	/ 34	x 6	MA 21	25	/ 37	x 6	MA 24
22	/ 34	x 10	MA 21	25	/ 37	x 7	MA 21
22	/ 34	x 10	MA 22	25	/ 38	x 7	MA 21
22	/ 35	x 7	MA 22	25	/ 38	x 9	MA 21
22	/ 35	x 10	MA 25	25	/ 38	x 9,5	MA 25
22	/ 36	x 8	MA 22	25	/ 38	x 10	MA 25
22	/ 37	x 10	MA 21	25	/ 38	x 10	MA 28
22	/ 37	x 10	MA 22	25	/ 38	x 10	MA 36
22	/ 38	x 8	MA 22	25	/ 40	x 6	MA 22
22	/ 38	x 10	MA 21	25	/ 40	x 9	MA 28
22	/ 38	x 10	MA 22	25	/ 40	x 10	MA 21
22	/ 40	x 10	MA 22	25	/ 40	x 10	MA 22
22	/ 40	x 10	MA 25	25	/ 40	x 10	MA 24
22	/ 42	x 10	MA 21	25	/ 40	x 10	MA 25
22	/ 42	x 10	MA 25	25	/ 40	x 10	MA 28
22	/ 46	x 12	MA 21	25	/ 40	x 10	MA 30
23	/ 38	x 10	MA 21	25	/ 40	x 10	MA 39
23	/ 38	x 10	MA 22	25	/ 40	x 11	MA 21
24	/ 30	x 8	MA 36	25	/ 42	x 8	MA 21
24	/ 32	x 4	MA 21	25	/ 42	x 8	MA 22
24	/ 32	x 5,5	MA 23	25	/ 45	x 10	MA 21
24	/ 32	x 5,5	MA 24	25	/ 45	x 10	MA 22
24	/ 32	x 5,5	MA 28	25	/ 45	x 12	MA 21
24	/ 32	x 5,7	MA 28	25	/ 45	x 12	MA 22
24	/ 32	x 6	MA 36	25	/ 45	x 12	MA 28
25	/ 32	x 7	MA 21	25	/ 45	x 12	MA 28
25	/ 50	x 10	MA 21	25	/ 50	x 10	MA 21
25	/ 50	x 10	MA 22	25	/ 50	x 10	MA 22
26,99	/ 39,69	x 6,35	MA 23	26	/ 38	x 8	MA 25
26	/ 38	x 8	MA 25	26	/ 42	x 8	MA 21
26	/ 42	x 8	MA 21	26	/ 46	x 10	MA 21
26	/ 46	x 10	MA 21	26	/ 46	x 10	MA 22
26	/ 46	x 10	MA 22	27	/ 35	x 4	MA 21
27	/ 35	x 4	MA 21	30	/ 38	x 7	MA 22
30	/ 38	x 7	MA 22	30	/ 38	x 7	MA 25
30	/ 38	x 7	MA 25	30	/ 38	x 8	MA 30
30	/ 38	x 8	MA 30	30	/ 38	x 8	MA 35
30	/ 38	x 8	MA 35	30	/ 38	x 8	MA 36
30	/ 38	x 8	MA 36	30	/ 40	x 5	MA 21
30	/ 40	x 5	MA 21	30	/ 40	x 5	MA 22
30	/ 40	x 5	MA 22	30	/ 40	x 5	MA 25
30	/ 40	x 5	MA 25	30	/ 40	x 6,5	MA 25
30	/ 40	x 6,5	MA 25	30	/ 40	x 7	MA 21
30	/ 40	x 7	MA 21	30	/ 40	x 7	MA 23
30	/ 40	x 7	MA 23	30	/ 40	x 7	MA 24
30	/ 40	x 7	MA 24	30	/ 40	x 7	MA 28
30	/ 40	x 7	MA 28	30	/ 40	x 7	MA 30
30	/ 40	x 7	MA 30	30	/ 40	x 7	MA 36
30	/ 40	x 7	MA 36	30	/ 40	x 9	MA 22
30	/ 40	x 9	MA 22	30	/ 40	x 10	MA 21
30	/ 40	x 10	MA 21	30	/ 40	x 10	MA 25
30	/ 40	x 10	MA 25	30	/ 40	x 10	MA 28
30	/ 40	x 10	MA 28	30	/ 40	x 10	MA 30
30	/ 40	x 10	MA 30	30	/ 40	x 10	MA 36
30	/ 40	x 10	MA 36	30	/ 40	x 10	MA 39
30	/ 40	x 10	MA 39	30	/ 40	x 11,5	MA 21
30	/ 40	x 11,5	MA 21	30	/ 41	x 8	MA 22
30	/ 41	x 8	MA 22	30	/ 42	x 9	MA 25
30	/ 42	x 9	MA 25	30	/ 42	x 10	MA 21
30	/ 42	x 10	MA 21	30	/ 42	x 10	MA 22
30	/ 42	x 10	MA 22	30	/ 42	x 10	MA 25
30	/ 42	x 10	MA 25	30	/ 45	x 9	MA 25
30	/ 45	x 9	MA 25	30	/ 45	x 10	MA 21
30	/ 45	x 10	MA 21	30	/ 45	x 10	MA 22
30	/ 45	x 10	MA 22	30	/ 45	x 10	MA 25
30	/ 45	x 10	MA 25	30	/ 45	x 10	MA 30
30	/ 45	x 10	MA 30	30	/ 47	x 10	MA 21
30	/ 47	x 10	MA 21	30	/ 50	x 10	MA 21
30	/ 50	x 10	MA 21	30	/ 50	x 10	MA 22
30	/ 50	x 10	MA 22	30	/ 50	x 10	MA 25
30	/ 50	x 10	MA 25	30	/ 50	x 12	MA 21
30	/ 50	x 12	MA 21	30	/ 50	x 12	MA 22
30	/ 50	x 12	MA 22	30	/ 50	x 12	MA 25
30	/ 50	x 12	MA 25	30	/ 50	x 12	MA 28
30	/ 50	x 12	MA 28	30	/ 50	x 12	MA 39
30	/ 50	x 12	MA 39	30	/ 55	x 12	MA 21
30	/ 55	x 12	MA 21	30	/ 55	x 12	MA 22
30	/ 55	x 12	MA 22	30	/ 60	x 15	MA 21
30	/ 60	x 15	MA 21	30	/ 60	x 15	MA 22
30	/ 60	x 15	MA 22	31,5	/ 41,5	x 6	MA 21
31,5	/ 41,5	x 6	MA 21	31,75	/ 38,1	x 6,98	MA 24
31,75	/ 38,1	x 6,98	MA 24	31,75	/ 47,62	x 9,52	MA 23
31,75	/ 47,62	x 9,52	MA 23	32	/ 40	x 4	MA 21
32	/ 40	x 4	MA 21	32	/ 40	x 4	MA 25
32	/ 40	x 4	MA 25	32	/ 40	x 4	MA 25
32	/ 40	x 5	MA 24	32	/ 40	x 5	MA 24
32	/ 40	x 5	MA 25	32	/ 40	x 5	MA 25
32	/ 40	x 5,5	MA 25	32	/ 40	x 5,5	MA 25
32	/ 40	x 5,5	MA 25	32	/ 40	x 5,7	MA 30
32	/ 40	x 5,7	MA 30	32	/ 40	x 5,8	MA 36
32	/ 40	x 5,8	MA 36	32	/ 40	x 6	MA 25
32	/ 40	x 6	MA 25	32	/ 40	x 6	MA 36
32	/ 40	x 6	MA 36	32	/ 40	x 6	MA 36
32	/ 40	x 7	MA 21	32	/ 40	x 7	MA 21
32	/ 40	x 7	MA 21	32	/ 40	x 7	MA 21
32	/ 40	x 8	MA 21	32	/ 40	x 8	MA 21
32	/ 40	x 8	MA 21	32	/ 40	x 8	MA 25
32	/ 40	x 8	MA 25	32	/ 40	x 8	MA 30
32	/ 40	x 8	MA 30	32	/ 40	x 8	MA 30
32	/ 40	x 8	MA 30	32	/ 40	x 8	MA 36
32	/ 40	x 8	MA 36	32	/ 40	x 8	MA 36
32	/ 40	x 8	MA 36	32	/ 40	x 8	MA 36

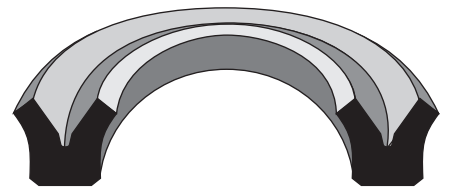

32 / 42 x 6				45 / 53 x 6			
d	/ D	x h	typ	d	/ D	x h	typ
32	/ 42	x 6	MA 21	35	/ 55	x 10	MA 25
32	/ 42	x 7	MA 24	35	/ 55	x 12	MA 21
32	/ 42	x 7	MA 30	35	/ 55	x 12	MA 22
32	/ 42	x 7	MA 35	35	/ 55	x 12	MA 25
32	/ 42	x 7	MA 36	35	/ 55	x 12	MA 28
32	/ 42	x 7,2	MA 30	35	/ 60	x 12	MA 21
32	/ 42	x 8	MA 36	35	/ 60	x 12	MA 22
32	/ 42	x 10	MA 22	36,51	/ 50,8	x 7,93	MA 24
32	/ 42	x 10	MA 25	36	/ 44	x 4	MA 25
32	/ 42	x 10	MA 30	36	/ 44	x 5,7	MA 25
32	/ 42	x 10	MA 36	36	/ 44	x 5,7	MA 30
32	/ 45	x 10	MA 21	36	/ 44	x 6	MA 36
32	/ 45	x 10	MA 22	36	/ 44	x 8	MA 36
32	/ 45	x 10	MA 25	36	/ 46	x 7	MA 25
32	/ 45	x 10	MA 30	36	/ 46	x 7	MA 36
32	/ 45	x 10	MA 39	36	/ 46	x 7,2	MA 30
32	/ 47	x 10	MA 21	36	/ 46	x 10	MA 30
32	/ 47	x 10	MA 22	36	/ 46	x 10	MA 36
32	/ 47	x 10	MA 25	36	/ 50	x 7	MA 22
32	/ 47	x 10	MA 30	36	/ 50	x 8	MA 21
32	/ 47	x 10	MA 39	36	/ 51	x 7,1	MA 21
32	/ 50	x 10	MA 22	36	/ 51	x 7,5	MA 21
32	/ 50	x 10	MA 25	36	/ 51	x 10	MA 21
32	/ 50	x 12	MA 21	36	/ 51	x 10	MA 22
32	/ 50	x 12	MA 25	36	/ 51	x 11,5	MA 30
32	/ 52	x 10	MA 21	36	/ 52	x 10	MA 21
32	/ 52	x 10	MA 22	37	/ 47	x 7	MA 35
33,33	/ 40,64	x 4,76	MA 24	38,1	/ 47,62	x 8,73	MA 24
33	/ 40	x 8	MA 28	38,1	/ 50,8	x 9,52	MA 24
33	/ 43	x 6	MA 21	38	/ 45	x 6	MA 36
33	/ 43	x 7,3	MA 28	38	/ 46	x 6,5	MA 25
33	/ 43	x 10	MA 25	38	/ 50	x 6	MA 21
34,92	/ 44,45	x 7	MA 23	38	/ 50	x 6	MA 22
34,92	/ 50,8	x 7,93	MA 24	38	/ 50	x 9	MA 25
34	/ 44	x 7	MA 24	38	/ 52,5	x 9	MA 21
34	/ 45	x 9	MA 25	38	/ 52,5	x 9,5	MA 21
35,23	/ 49,21	x 9,52	MA 23	38	/ 53	x 10	MA 21
35,5	/ 45,5	x 6	MA 21	38	/ 53	x 10	MA 22
35	/ 43	x 5,7	MA 30	38	/ 55	x 10	MA 21
35	/ 43	x 5,8	MA 35	38	/ 55	x 10	MA 25
35	/ 43	x 6	MA 36	38	/ 55	x 10	MA 39
35	/ 43	x 7	MA 39	38	/ 58	x 10	MA 21
35	/ 43	x 8	MA 30	38	/ 58	x 10	MA 22
35	/ 43	x 8	MA 36	38	/ 58	x 10	MA 25
35	/ 45	x 5	MA 22	38	/ 58	x 12	MA 21
35	/ 45	x 6	MA 22	38	/ 58	x 12	MA 22
35	/ 45	x 6	MA 25	38	/ 58	x 12	MA 22
35	/ 45	x 7	MA 24	38	/ 74	x 6	MA 21
35	/ 45	x 7	MA 36	39,69	/ 55,96	x 9,52	MA 24
35	/ 45	x 7,2	MA 30	39,7	/ 51	x 8	MA 21
35	/ 45	x 8	MA 25	40	/ 48	x 5,4	MA 35
35	/ 45	x 10	MA 21	40	/ 48	x 5,7	MA 30
35	/ 45	x 10	MA 25	40	/ 48	x 6	MA 36
35	/ 45	x 10	MA 30	40	/ 48	x 6,3	MA 35
35	/ 45	x 10	MA 36	40	/ 48	x 8	MA 30
35	/ 48	x 10	MA 25	40	/ 48	x 8	MA 35
35	/ 48	x 10	MA 28	40	/ 48	x 8	MA 36
35	/ 50	x 7	MA 21	40	/ 48	x 11	MA 25
35	/ 50	x 8,5	MA 28	40	/ 50	x 5	MA 21
35	/ 50	x 9,5	MA 21	40	/ 50	x 5	MA 22
35	/ 50	x 10	MA 21	40	/ 50	x 5	MA 25
35	/ 50	x 10	MA 22	40	/ 50	x 6	MA 21
35	/ 50	x 10	MA 25	40	/ 50	x 6,5	MA 25
35	/ 50	x 10	MA 28	40	/ 50	x 7	MA 21
35	/ 50	x 10	MA 30	40	/ 50	x 7	MA 24
35	/ 50	x 10	MA 39	40	/ 50	x 7	MA 25
35	/ 52	x 12	MA 21	40	/ 50	x 7	MA 28
35	/ 52	x 12	MA 22	40	/ 50	x 7	MA 35
35	/ 55	x 10	MA 21	40	/ 50	x 7,2	MA 30
35	/ 55	x 10	MA 22	40	/ 50	x 8	MA 25
35	/ 55	x 10	MA 22	40	/ 50	x 8	MA 30
35	/ 55	x 10	MA 22	40	/ 50	x 8	MA 30
35	/ 55	x 10	MA 22	40	/ 50	x 9	MA 24
				40	/ 50	x 9	MA 24
				40	/ 50	x 10	MA 21
				40	/ 50	x 10	MA 25
				40	/ 50	x 10	MA 28
				40	/ 50	x 10	MA 30
				40	/ 50	x 10	MA 35
				40	/ 50	x 10	MA 36
				40	/ 52	x 7	MA 21
				40	/ 52	x 12	MA 21
				40	/ 55	x 7,2	MA 30
				40	/ 55	x 9,5	MA 21
				40	/ 55	x 10	MA 21
				40	/ 55	x 10	MA 22
				40	/ 55	x 10	MA 24
				40	/ 55	x 10	MA 25
				40	/ 55	x 10	MA 30
				40	/ 55	x 11,5	MA 30
				40	/ 56	x 8	MA 22
				40	/ 56	x 10	MA 21
				40	/ 56	x 10	MA 22
				40	/ 56	x 10	MA 25
				40	/ 58	x 10	MA 21
				40	/ 58	x 10	MA 22
				40	/ 60	x 10	MA 21
				40	/ 60	x 10	MA 22
				40	/ 60	x 10	MA 25
				40	/ 60	x 10	MA 21
				40	/ 60	x 12	MA 21
				40	/ 60	x 12	MA 22
				40	/ 60	x 12	MA 25
				40	/ 60	x 12	MA 28
				40	/ 60	x 13	MA 25
				40	/ 60	x 18	MA 25
				40	/ 65	x 12	MA 21
				40	/ 65	x 12	MA 22
				40	/ 65	x 15	MA 21
				40	/ 70	x 15	MA 22
				41,27	/ 50,8	x 5,56	MA 24
				41,27	/ 50,8	x 7,14	MA 23
				41,27	/ 53,97	x 9,52	MA 23
				41,27	/ 57,15	x 9,52	MA 23
				41	/ 56	x 8,5	MA 21
				41	/ 56	x 10	MA 21
				41	/ 56	x 10	MA 22
				41	/ 57	x 11,4	MA 28
				42,86	/ 53,97	x 9,52	MA 24
				42	/ 50	x 5	MA 21
				42	/ 50	x 6	MA 21
				42	/ 50	x 6	MA 36
				42	/ 50	x 8	MA 25
				42	/ 50	x 8	MA 28
				42	/ 52	x 6	MA 22
				42	/ 52	x 7	MA 24
				42	/ 53	x 9	MA 36
				42	/ 55	x 6,5	MA 22
				42	/ 55	x 8	MA 21
				42	/ 57	x 10	MA 21
				42	/ 57	x 10	MA 22
				42	/ 62	x 12	MA 21
				42	/ 62	x 12	MA 22
				43	/ 63	x 10	MA 21
				43	/ 63	x 10	MA 22
				43	/ 63	x 12	MA 28
				44,45	/ 57,15	x 6,35	MA 23
				44,45	/ 57,15	x 7,93	MA 24
				44	/ 54	x 7	MA 28
				44	/ 55	x 6	MA 22
				44	/ 57	x 9	MA 21
				45,7	/ 63,5	x 8,85	MA 23
				45	/ 52	x 8	MA 22
				45	/ 53	x 5,7	MA 25
				45	/ 53	x 5,7	MA 30
				45	/ 53	x 6	MA 36

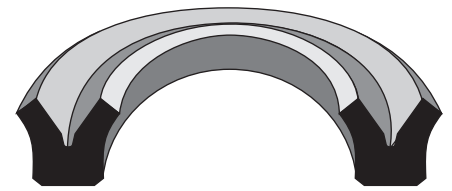

45 / 53 x 8				60 / 70 x 5							
d	/ D	x h	typ								
45	/ 53	x 8	MA 30	50	/ 57	x 10	MA 39	55	/ 63	x 5,7	MA 28
45	/ 53	x 8	MA 35	50	/ 58	x 8	MA 25	55	/ 63	x 8	MA 30
45	/ 53	x 8	MA 36	50	/ 58	x 8	MA 35	55	/ 63	x 8	MA 36
45	/ 53	x 10	MA 30	50	/ 58	x 8	MA 36	55	/ 65	x 5	MA 25
45	/ 53	x 10	MA 36	50	/ 60	x 5	MA 25	55	/ 65	x 7	MA 23
45	/ 53	x 12	MA 25	50	/ 60	x 7	MA 21	55	/ 65	x 7,2	MA 30
45	/ 53	x 12	MA 30	50	/ 60	x 7	MA 24	55	/ 65	x 7,2	MA 36
45	/ 55	x 5	MA 25	50	/ 60	x 7	MA 28	55	/ 65	x 7,3	MA 28
45	/ 55	x 5,7	MA 30	50	/ 60	x 7	MA 35	55	/ 65	x 7,5	MA 36
45	/ 55	x 5,8	MA 35	50	/ 60	x 7	MA 36	55	/ 65	x 10	MA 25
45	/ 55	x 6	MA 21	50	/ 60	x 7,2	MA 25	55	/ 65	x 10	MA 30
45	/ 55	x 6,5	MA 25	50	/ 60	x 7,2	MA 30	55	/ 65	x 10	MA 36
45	/ 55	x 7	MA 23	50	/ 60	x 8	MA 21	55	/ 65	x 10	MA 39
45	/ 55	x 7	MA 24	50	/ 60	x 8	MA 28	55	/ 65	x 12	MA 21
45	/ 55	x 7	MA 35	50	/ 60	x 9	MA 35	55	/ 65	x 12	MA 25
45	/ 55	x 7	MA 36	50	/ 60	x 10	MA 21	55	/ 65	x 12	MA 30
45	/ 55	x 7,2	MA 30	50	/ 60	x 10	MA 22	55	/ 65	x 12	MA 36
45	/ 55	x 10	MA 21	50	/ 60	x 10	MA 25	55	/ 65	x 12	MA 39
45	/ 55	x 10	MA 25	50	/ 60	x 10	MA 28	55	/ 67	x 10	MA 30
45	/ 55	x 10	MA 36	50	/ 60	x 10	MA 30	55	/ 70	x 7,5	MA 21
45	/ 55	x 10	MA 39	50	/ 60	x 10	MA 36	55	/ 70	x 7,5	MA 22
45	/ 57	x 6	MA 21	50	/ 60	x 10	MA 39	55	/ 70	x 10	MA 21
45	/ 57	x 6	MA 22	50	/ 60	x 10	MA 25	55	/ 70	x 10	MA 25
45	/ 58	x 10	MA 21	50	/ 60	x 11	MA 25	55	/ 70	x 10	MA 30
45	/ 58	x 10	MA 22	50	/ 62	x 6	MA 22	55	/ 70	x 10	MA 39
45	/ 60	x 7	MA 22	50	/ 62	x 8	MA 36	55	/ 70	x 10	MA 25
45	/ 60	x 10	MA 21	50	/ 62	x 9	MA 21	55	/ 70	x 12	MA 28
45	/ 60	x 10	MA 22	50	/ 62	x 9	MA 25	55	/ 70	x 12	MA 30
45	/ 60	x 10	MA 25	50	/ 63	x 6	MA 25	55	/ 70	x 12	MA 21
45	/ 60	x 10	MA 28	50	/ 63	x 8	MA 21	55	/ 75	x 10	MA 21
45	/ 60	x 10	MA 30	50	/ 63	x 9	MA 21	55	/ 75	x 10	MA 22
45	/ 60	x 10	MA 39	50	/ 63	x 10	MA 25	55	/ 75	x 10	MA 25
45	/ 60	x 11,5	MA 30	50	/ 63	x 10	MA 28	55	/ 75	x 12	MA 21
45	/ 63	x 10	MA 21	50	/ 64	x 8	MA 28	55	/ 75	x 12	MA 25
45	/ 63	x 10	MA 21	50	/ 65	x 10	MA 21	55	/ 75	x 12	MA 28
45	/ 63	x 10	MA 22	50	/ 65	x 10	MA 22	55	/ 75	x 12	MA 39
45	/ 63	x 10	MA 25	50	/ 65	x 10	MA 25	55	/ 75	x 12	MA 21
45	/ 63	x 12	MA 21	50	/ 65	x 10	MA 28	55	/ 80	x 12	MA 21
45	/ 63	x 12	MA 28	50	/ 65	x 10	MA 30	55	/ 80	x 12	MA 22
45	/ 65	x 10	MA 21	50	/ 65	x 10	MA 36	55	/ 80	x 12	MA 25
45	/ 65	x 10	MA 22	50	/ 65	x 11,5	MA 30	55	/ 80	x 15	MA 21
45	/ 65	x 10	MA 25	50	/ 65	x 12	MA 21	55	/ 85	x 10	MA 21
45	/ 65	x 12	MA 21	50	/ 68	x 12	MA 21	55	/ 85	x 10	MA 22
45	/ 65	x 12	MA 22	50	/ 70	x 8	MA 21	55	/ 85	x 15	MA 21
45	/ 65	x 12	MA 25	50	/ 70	x 10	MA 21	55	/ 85	x 15	MA 22
45	/ 65	x 12	MA 25	50	/ 70	x 10	MA 22	56	/ 61	x 8	MA 22
45	/ 69	x 12	MA 22	50	/ 70	x 10	MA 25	56	/ 66	x 6,5	MA 23
46,04	/ 60,32	x 9,52	MA 24	50	/ 70	x 12	MA 21	56	/ 66	x 6,7	MA 25
46	/ 56	x 6	MA 28	50	/ 70	x 12	MA 22	56	/ 66	x 10	MA 30
46	/ 70	x 12	MA 21	50	/ 70	x 12	MA 25	56	/ 66	x 10	MA 39
46	/ 70	x 12	MA 22	50	/ 70	x 12	MA 28	56	/ 68	x 8,5	MA 24
47,62	/ 60,32	x 6,35	MA 23	50	/ 70	x 12	MA 30	56	/ 71	x 8,5	MA 36
47	/ 55	x 8	MA 36	50	/ 70	x 12	MA 39	56	/ 71	x 10	MA 21
47	/ 65	x 12	MA 21	50	/ 70	x 14	MA 23	56	/ 71	x 10	MA 25
48	/ 58	x 10	MA 25	50	/ 70	x 18	MA 25	56	/ 71	x 11,5	MA 30
48	/ 60	x 6	MA 22	50	/ 72	x 12	MA 21	56	/ 71	x 11,5	MA 35
48	/ 63	x 9	MA 28	50	/ 74	x 12	MA 21	56	/ 76	x 12	MA 21
48	/ 63	x 10	MA 21	50	/ 75	x 12	MA 21	56	/ 80	x 15	MA 21
48	/ 63	x 10	MA 22	50	/ 75	x 12	MA 22	57,15	/ 69,85	x 7,93	MA 24
48	/ 63	x 10	MA 25	50	/ 75	x 15	MA 21	57,15	/ 69,85	x 9,52	MA 39
48	/ 63	x 10	MA 25	51	/ 64	x 9	MA 21	57	/ 67	x 7,3	MA 28
48	/ 63	x 10	MA 39	52	/ 60	x 5,5	MA 36	58,04	/ 76,2	x 8,73	MA 23
48	/ 63	x 11,4	MA 28	52	/ 62	x 10	MA 30	58	/ 68	x 9,5	MA 28
48	/ 63	x 12	MA 21	52	/ 62	x 10	MA 39	58	/ 70	x 6	MA 21
48	/ 63	x 12	MA 28	52	/ 62	x 12	MA 25	58	/ 70	x 8,5	MA 23
48	/ 63	x 12	MA 28	52	/ 62	x 12	MA 25	58	/ 77	x 9,5	MA 21
48	/ 68	x 10	MA 22	52	/ 72	x 12	MA 21	58	/ 78	x 12	MA 21
48	/ 68	x 12	MA 21	53,97	/ 69,85	x 9,52	MA 24	58	/ 78	x 12	MA 22
48	/ 68	x 12	MA 22	53	/ 63	x 5	MA 25	59	/ 80	x 14	MA 21
49,21	/ 66,67	x 9,52	MA 24	53	/ 63	x 6	MA 23	60,32	/ 76,2	x 7,93	MA 24
50,8	/ 60,32	x 10,31	MA 24	53	/ 63	x 6,5	MA 25	60	/ 68	x 8	MA 25
50,8	/ 69,85	x 12,7	MA 23	53	/ 63	x 7	MA 23	60	/ 68	x 13	MA 36
50,8	/ 73,02	x 11,11	MA 24	53	/ 63	x 7	MA 28	60	/ 70	x 5	MA 25
				53	/ 63	x 12	MA 28				

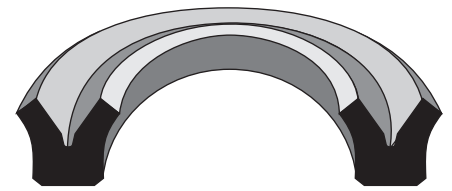

60 / 70 x 6				80 / 90 x 10							
d	/ D	x h	typ								
60	/ 70	x 6	MA 21	65	/ 75	x 12	MA 30	70	/ 90	x 12	MA 28
60	/ 70	x 7	MA 36	65	/ 75	x 12	MA 36	70	/ 90	x 12	MA 30
60	/ 70	x 7,2	MA 30	65	/ 77,7	x 9,5	MA 35	70	/ 90	x 12	MA 39
60	/ 70	x 7,5	MA 36	65	/ 77	x 8,5	MA 24	70	/ 90	x 15	MA 21
60	/ 70	x 8	MA 25	65	/ 78	x 10	MA 30	70	/ 90	x 15	MA 39
60	/ 70	x 10	MA 25	65	/ 80	x 7,5	MA 22	70	/ 90	x 18	MA 25
60	/ 70	x 10	MA 30	65	/ 80	x 8,6	MA 28	70	/ 95	x 12	MA 21
60	/ 70	x 10	MA 36	65	/ 80	x 9	MA 21	70	/ 95	x 12	MA 22
60	/ 70	x 10	MA 39	65	/ 80	x 10	MA 25	70	/ 95	x 12	MA 25
60	/ 70	x 12	MA 21	65	/ 80	x 11	MA 25	70	/ 95	x 15	MA 21
60	/ 70	x 12	MA 25	65	/ 80	x 11,4	MA 28	70	/ 100	x 10	MA 21
60	/ 70	x 12	MA 28	65	/ 80	x 12	MA 21	70	/ 100	x 15	MA 21
60	/ 70	x 12	MA 30	65	/ 80	x 12	MA 25	71,43	/ 82,55	x 6,93	MA 23
60	/ 70	x 12	MA 36	65	/ 80	x 12	MA 30	71,9	/ 83	x 7,5	MA 23
60	/ 72	x 8,5	MA 24	65	/ 85	x 10	MA 21	71	/ 79	x 8	MA 36
60	/ 72	x 9	MA 36	65	/ 85	x 10	MA 22	72	/ 80	x 10	MA 21
60	/ 75	x 8	MA 21	65	/ 85	x 10	MA 25	72	/ 80	x 10	MA 22
60	/ 75	x 10	MA 21	65	/ 85	x 12	MA 21	72	/ 80	x 12	MA 21
60	/ 75	x 10	MA 25	65	/ 85	x 12	MA 22	72	/ 80	x 12	MA 28
60	/ 75	x 10	MA 30	65	/ 85	x 12	MA 30	72	/ 82	x 5	MA 21
60	/ 75	x 10	MA 39	65	/ 85	x 12	MA 39	72	/ 90	x 10	MA 21
60	/ 75	x 11,5	MA 30	65	/ 90	x 8	MA 21	72	/ 90	x 11	MA 21
60	/ 75	x 12	MA 22	65	/ 90	x 12	MA 21	73,02	/ 82,55	x 9,52	MA 24
60	/ 75	x 12	MA 25	65	/ 90	x 12	MA 22	73	/ 80	x 8	MA 36
60	/ 75	x 12	MA 28	65	/ 90	x 12	MA 28	73	/ 85	x 8,5	MA 23
60	/ 75	x 12	MA 30	65	/ 90	x 13	MA 21	73	/ 93	x 11	MA 21
60	/ 75	x 12	MA 39	65	/ 90	x 15	MA 21	75	/ 83	x 8	MA 35
60	/ 76	x 8	MA 21	65	/ 95	x 12	MA 21	75	/ 83	x 8	MA 36
60	/ 80	x 10	MA 21	65	/ 95	x 12	MA 22	75	/ 83	x 12	MA 21
60	/ 80	x 10	MA 25	65	/ 95	x 13	MA 21	75	/ 85	x 7,2	MA 30
60	/ 80	x 12	MA 21	65	/ 95	x 13	MA 21	75	/ 85	x 7,2	MA 36
60	/ 80	x 12	MA 22	65	/ 100	x 12	MA 21	75	/ 85	x 12	MA 21
60	/ 80	x 12	MA 25	66,67	/ 79,37	x 6,35	MA 23	75	/ 85	x 12	MA 25
60	/ 80	x 12	MA 28	66,67	/ 79,37	x 9,52	MA 24	75	/ 85	x 12	MA 30
60	/ 80	x 12	MA 30	66	/ 77	x 6	MA 21	75	/ 85	x 12	MA 36
60	/ 80	x 12	MA 39	67	/ 77	x 10	MA 25	75	/ 85	x 12	MA 36
60	/ 80	x 12	MA 28	67	/ 77	x 12	MA 25	75	/ 87	x 8,6	MA 30
60	/ 80	x 18	MA 25	68	/ 80	x 8,5	MA 23	75	/ 87	x 9	MA 36
60	/ 85	x 15	MA 21	68	/ 80	x 12	MA 21	75	/ 90	x 7,5	MA 25
60	/ 85	x 15	MA 22	69,85	/ 82,55	x 9,52	MA 39	75	/ 90	x 10	MA 21
60	/ 90	x 15	MA 21	69,85	/ 90,9	x 9,52	MA 24	75	/ 90	x 10	MA 25
60	/ 90	x 15	MA 22	70	/ 78	x 8	MA 36	75	/ 90	x 10	MA 30
60	/ 90	x 15	MA 25	70	/ 80	x 8	MA 25	75	/ 90	x 11,4	MA 28
60	/ 95	x 13	MA 21	70	/ 80	x 6	MA 25	75	/ 90	x 12	MA 25
61	/ 80	x 12	MA 21	70	/ 80	x 6,5	MA 36	75	/ 90	x 12	MA 28
63,5	/ 73,02	x 5,56	MA 23	70	/ 80	x 6,7	MA 28	75	/ 90	x 12	MA 30
63,5	/ 76,2	x 9,52	MA 39	70	/ 80	x 8	MA 25	75	/ 90	x 12	MA 39
63	/ 71	x 8	MA 36	70	/ 80	x 8	MA 28	75	/ 95	x 10	MA 21
63	/ 72	x 6	MA 21	70	/ 80	x 10	MA 25	75	/ 95	x 10	MA 22
63	/ 73	x 5	MA 25	70	/ 80	x 12	MA 21	75	/ 95	x 12	MA 21
63	/ 75	x 8,5	MA 23	70	/ 80	x 12	MA 25	75	/ 95	x 12	MA 25
63	/ 75	x 8,5	MA 24	70	/ 80	x 12	MA 28	75	/ 100	x 12	MA 22
63	/ 75	x 8,5	MA 36	70	/ 80	x 12	MA 30	75	/ 100	x 15	MA 21
63	/ 75	x 8,7	MA 28	70	/ 80	x 12	MA 36	75	/ 100	x 15	MA 22
63	/ 75	x 8,7	MA 30	70	/ 80	x 13	MA 21	75	/ 105	x 15	MA 21
63	/ 75	x 10	MA 25	70	/ 82	x 8,5	MA 24	75	/ 105	x 15	MA 22
63	/ 78	x 10	MA 25	70	/ 82	x 9	MA 30	76,2	/ 88,9	x 6,35	MA 23
63	/ 78	x 10	MA 30	70	/ 85	x 7,5	MA 22	76,2	/ 88,9	x 9,52	MA 24
63	/ 78	x 11,5	MA 30	70	/ 85	x 8	MA 21	76,2	/ 91,2	x 12	MA 35
63	/ 83	x 12	MA 21	70	/ 85	x 10	MA 30	76,99	/ 95,25	x 7,4	MA 23
63	/ 83	x 13,5	MA 39	70	/ 85	x 11,5	MA 30	76	/ 84	x 8	MA 36
63	/ 83	x 15	MA 25	70	/ 85	x 11,5	MA 35	78	/ 86	x 8	MA 36
63	/ 83	x 15	MA 30	70	/ 85	x 12	MA 25	78	/ 88	x 5	MA 21
64	/ 72	x 8	MA 36	70	/ 85	x 12	MA 28	78	/ 90	x 8,5	MA 23
64	/ 76	x 9	MA 21	70	/ 85	x 12	MA 30	78	/ 93	x 10,5	MA 36
64	/ 80	x 8	MA 22	70	/ 85	x 12	MA 36	79,37	/ 98,42	x 9,52	MA 24
65	/ 73	x 8	MA 36	70	/ 90	x 10	MA 21	80	/ 88	x 8	MA 35
65	/ 73	x 11,5	MA 36	70	/ 90	x 10	MA 22	80	/ 88	x 8	MA 36
65	/ 75	x 10	MA 21	70	/ 90	x 10	MA 25	80	/ 90	x 5	MA 25
65	/ 75	x 10	MA 30	70	/ 90	x 12	MA 21	80	/ 90	x 7,2	MA 30
65	/ 75	x 12	MA 25	70	/ 90	x 12	MA 22	80	/ 90	x 7,2	MA 36
				70	/ 90	x 12	MA 25	80	/ 90	x 10	MA 25

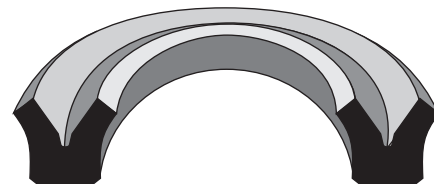

80 / 90 x 10

d	/ D	x h	typ
80	/ 90	x 10	MA 36
80	/ 90	x 10,5	MA 30
80	/ 90	x 12	MA 25
80	/ 90	x 12	MA 30
80	/ 90	x 14	MA 36
80	/ 92	x 8,5	MA 24
80	/ 92	x 8,6	MA 30
80	/ 92	x 9	MA 36
80	/ 93	x 10	MA 30
80	/ 95	x 8	MA 21
80	/ 95	x 9	MA 21
80	/ 95	x 11,5	MA 30
80	/ 95	x 11,5	MA 35
80	/ 95	x 11,5	MA 36
80	/ 95	x 12	MA 21
80	/ 95	x 12	MA 25
80	/ 95	x 12	MA 28
80	/ 95	x 12	MA 30
80	/ 95	x 12	MA 39
80	/ 100	x 10	MA 21
80	/ 100	x 10	MA 22
80	/ 100	x 10	MA 25
80	/ 100	x 12	MA 21
80	/ 100	x 12	MA 25
80	/ 100	x 12	MA 28
80	/ 100	x 12	MA 30
80	/ 100	x 13,5	MA 28
80	/ 100	x 15	MA 21
80	/ 100	x 15	MA 28
80	/ 100	x 15	MA 39
80	/ 105	x 12	MA 21
80	/ 105	x 12	MA 22
80	/ 105	x 12	MA 25
80	/ 105	x 15	MA 21
80	/ 110	x 15	MA 21
80	/ 110	x 15	MA 22
80	/ 110	x 18	MA 21
80	/ 110	x 18	MA 22
80	/ 115	x 12,5	MA 21
81	/ 89	x 8	MA 36
82,55	/ 95,25	x 7,93	MA 24
82,55	/ 95,25	x 9,52	MA 39
82	/ 92	x 10	MA 21
82	/ 92	x 10	MA 25
82	/ 108	x 12	MA 21
83	/ 103	x 14	MA 21
84	/ 103	x 14	MA 21
85,72	/ 98,42	x 9,52	MA 23
85,72	/ 98,42	x 9,52	MA 24
85	/ 93	x 6,5	MA 36
85	/ 94	x 15	MA 36
85	/ 95	x 7	MA 24
85	/ 95	x 8,5	MA 25
85	/ 95	x 9	MA 21
85	/ 95	x 12	MA 25
85	/ 97	x 9	MA 36
85	/ 100	x 8	MA 25
85	/ 100	x 9	MA 25
85	/ 100	x 10	MA 23
85	/ 100	x 11	MA 25
85	/ 100	x 11,4	MA 28
85	/ 100	x 11,5	MA 30
85	/ 100	x 12	MA 21
85	/ 100	x 12	MA 23
85	/ 100	x 12	MA 25
85	/ 100	x 12	MA 28
85	/ 100	x 12	MA 30
85	/ 100	x 12	MA 39
85	/ 105	x 10	MA 21
85	/ 105	x 10	MA 22

107 / 127 x 16

85	/ 105	x 12	MA 21
85	/ 105	x 12	MA 25
85	/ 105	x 12	MA 39
85	/ 105	x 15	MA 21
85	/ 105	x 18	MA 25
85	/ 110	x 12	MA 21
85	/ 110	x 12	MA 22
85	/ 110	x 15	MA 21
85	/ 115	x 15	MA 21
85	/ 115	x 15	MA 22
86	/ 105	x 16	MA 21
87	/ 95	x 8	MA 36
88,9	/ 101,6	x 9,52	MA 24
88,9	/ 101,6	x 9,52	MA 39
88,9	/ 107,95	x 12,7	MA 23
88	/ 96	x 8	MA 36
88	/ 100	x 8,5	MA 23
90	/ 98	x 8	MA 35
90	/ 98	x 8	MA 36
90	/ 100	x 5	MA 25
90	/ 100	x 8	MA 21
90	/ 100	x 8	MA 25
90	/ 100	x 10	MA 30
90	/ 100	x 10,5	MA 28
90	/ 100	x 12	MA 25
90	/ 102	x 8,5	MA 24
90	/ 102	x 9	MA 36
90	/ 105	x 7,5	MA 21
90	/ 105	x 8,5	MA 30
90	/ 105	x 10	MA 30
90	/ 105	x 11,5	MA 30
90	/ 105	x 11,5	MA 35
90	/ 105	x 11,5	MA 36
90	/ 105	x 12	MA 25
90	/ 105	x 12	MA 28
90	/ 105	x 12	MA 30
90	/ 105	x 12	MA 39
90	/ 110	x 10	MA 21
90	/ 110	x 10	MA 22
90	/ 110	x 10	MA 25
90	/ 110	x 12	MA 21
90	/ 110	x 12	MA 25
90	/ 110	x 12	MA 30
90	/ 110	x 12	MA 39
90	/ 110	x 13	MA 21
90	/ 110	x 15	MA 21
90	/ 110	x 15	MA 28
90	/ 110	x 18	MA 25
90	/ 110	x 18	MA 25
90	/ 110	x 123	MA 21
90	/ 112	x 12	MA 21
90	/ 115	x 12	MA 21
90	/ 115	x 12	MA 22
90	/ 115	x 15	MA 21
90	/ 115	x 12	MA 22
90	/ 115	x 15	MA 21
90	/ 115	x 15	MA 22
90	/ 115	x 15	MA 25
90	/ 115	x 15	MA 28
90	/ 120	x 15	MA 21
90	/ 120	x 18	MA 21
92,07	/ 76,2	x 9,52	MA 23
92,07	/ 111,12	x 9,52	MA 24
95	/ 103	x 12	MA 21
95	/ 105	x 12	MA 25
95	/ 105	x 12	MA 39
95	/ 110	x 9	MA 28
95	/ 110	x 10	MA 28
95	/ 110	x 12	MA 25
95	/ 110	x 15	MA 25
95	/ 110	x 15	MA 28
95	/ 115	x 10	MA 21
95	/ 115	x 10	MA 21

95	/ 115	x 10	MA 22
95	/ 115	x 12	MA 21
95	/ 115	x 12	MA 25
95	/ 115	x 12	MA 39
95	/ 115	x 15	MA 21
95	/ 115	x 15	MA 28
95	/ 115	x 18	MA 25
95	/ 120	x 12	MA 21
95	/ 120	x 13	MA 21
95	/ 125	x 13	MA 21
95	/ 125	x 13	MA 21
95	/ 125	x 15	MA 21
95	/ 125	x 15	MA 22
95	/ 125	x 18	MA 28
97	/ 105	x 8	MA 36
97	/ 105	x 13	MA 36
98,42	/ 107,95	x 9,52	MA 24
100	/ 108	x 8	MA 36
100	/ 110	x 5	MA 21
100	/ 110	x 5	MA 25
100	/ 115	x 10	MA 24
100	/ 115	x 11	MA 30
100	/ 115	x 12	MA 25
100	/ 115	x 12	MA 30
100	/ 115	x 12	MA 39
100	/ 120	x 10	MA 21
100	/ 120	x 10	MA 25
100	/ 120	x 11,5	MA 30
100	/ 120	x 12	MA 21
100	/ 120	x 12	MA 25
100	/ 120	x 12	MA 28
100	/ 120	x 12	MA 30
100	/ 120	x 12	MA 39
100	/ 120	x 14,5	MA 36
100	/ 120	x 15	MA 21
100	/ 120	x 15	MA 25
100	/ 120	x 15	MA 30
100	/ 120	x 15	MA 35
100	/ 120	x 15	MA 39
100	/ 120	x 18	MA 22
100	/ 125	x 12	MA 21
100	/ 125	x 12	MA 22
100	/ 125	x 12	MA 25
100	/ 125	x 15	MA 21
100	/ 125	x 15	MA 25
100	/ 125	x 15	MA 28
100	/ 125	x 15	MA 39
100	/ 130	x 12	MA 25
100	/ 130	x 15	MA 21
100	/ 130	x 15	MA 22
100	/ 130	x 18	MA 21
101,6	/ 111,12	x 5,75	MA 24
103	/ 111	x 10	MA 36
105	/ 113	x 6,5	MA 36
105	/ 120	x 10	MA 23
105	/ 120	x 12	MA 28
105	/ 120	x 15	MA 25
105	/ 125	x 10	MA 25
105	/ 125	x 12	MA 25
105	/ 125	x 12	MA 28
105	/ 125	x 14	MA 25
105	/ 125	x 15	MA 25
105	/ 125	x 15	MA 28
105	/ 130	x 12	MA 21
105	/ 130	x 12	MA 22
105	/ 130	x 18	MA 21
105	/ 135	x 18	MA 21
106	/ 130	x 18	MA 21
107,95	/ 127	x 9,52	MA 24
107	/ 115	x 8	MA 36
107	/ 127,4	x 16	MA 21

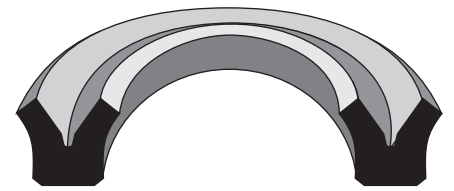

108 / 116 x 8

220 / 250 x 18

d	/ D	x h	typ
108	/ 116	x 8	MA 35
110	/ 125	x 9,6	MA 28
110	/ 125	x 12	MA 21
110	/ 125	x 12	MA 25
110	/ 125	x 15	MA 25
110	/ 130	x 10	MA 22
110	/ 130	x 12	MA 25
110	/ 130	x 12	MA 28
110	/ 130	x 12	MA 30
110	/ 130	x 12	MA 39
110	/ 130	x 14,5	MA 36
110	/ 130	x 15	MA 25
110	/ 130	x 15	MA 28
110	/ 130	x 15	MA 30
110	/ 130	x 15	MA 35
110	/ 130	x 15	MA 39
110	/ 130	x 18	MA 25
110	/ 135	x 12	MA 21
110	/ 135	x 12	MA 22
110	/ 135	x 18	MA 21
110	/ 140	x 15	MA 21
110	/ 140	x 15	MA 22
110	/ 140	x 18	MA 21
111,1	/ 130,1	x 15	MA 21
11,12	/ 123,82	x 9,52	MA 23
113	/ 125	x 9,5	MA 25
114,3	/ 146,05	x 12,7	MA 24
115	/ 123	x 12	MA 21
115	/ 124	x 15	MA 36
115	/ 125	x 8	MA 21
115	/ 130	x 15	MA 25
115	/ 135	x 15	MA 21
115	/ 135	x 15	MA 25
115	/ 140	x 12	MA 22
115	/ 140	x 15	MA 25
115	/ 140	x 18	MA 21
115	/ 145	x 12	MA 21
115	/ 145	x 18	MA 21
118	/ 126	x 13	MA 36
120,65	/ 136,52	x 7,14	MA 24
120	/ 130	x 5	MA 25
120	/ 130	x 11,5	MA 30
120	/ 135	x 15	MA 25
120	/ 140	x 10	MA 21
120	/ 140	x 10	MA 22
120	/ 140	x 10	MA 23
120	/ 140	x 10	MA 25
120	/ 140	x 12	MA 25
120	/ 140	x 12	MA 28
120	/ 140	x 12	MA 30
120	/ 140	x 12	MA 39
120	/ 140	x 14	MA 21
120	/ 140	x 15	MA 30
120	/ 140	x 15	MA 39
120	/ 145	x 18	MA 21
120	/ 150	x 15	MA 21
120	/ 150	x 15	MA 22
120	/ 150	x 18	MA 21
120	/ 150	x 18	MA 28
122	/ 130	x 8	MA 36
125	/ 140	x 9	MA 21
125	/ 140	x 10	MA 23
125	/ 140	x 11	MA 21
125	/ 140	x 11	MA 25
125	/ 140	x 15	MA 25
125	/ 140	x 15	MA 28
125	/ 145	x 10	MA 22
125	/ 145	x 12	MA 30
125	/ 145	x 15	MA 25
125	/ 145	x 15	MA 30

125	/ 145	x 15	MA 35
125	/ 150	x 18	MA 21
125	/ 150	x 18	MA 22
125	/ 154	x 20	MA 21
125	/ 155	x 15	MA 21
125	/ 155	x 15	MA 25
125	/ 155	x 18	MA 21
126	/ 134	x 8	MA 35
127	/ 101,6	x 15,87	MA 23
127	/ 146,05	x 12,7	MA 24
127	/ 151	x 16	MA 21
127	/ 152,4	x 15,87	MA 23
130	/ 150	x 10	MA 21
130	/ 150	x 14	MA 21
130	/ 150	x 15	MA 21
130	/ 150	x 15	MA 25
130	/ 150	x 15	MA 28
130	/ 150	x 15	MA 30
130	/ 155	x 18	MA 21
130	/ 160	x 15	MA 21
130	/ 160	x 15	MA 22
130	/ 160	x 18	MA 21
130	/ 160	x 18	MA 28
135	/ 143	x 12	MA 21
135	/ 150	x 15	MA 21
135	/ 150	x 15	MA 25
135	/ 155	x 15	MA 25
135	/ 160	x 12,7	MA 25
135	/ 160	x 18	MA 25
135	/ 160	x 18	MA 22
135	/ 160	x 18,5	MA 28
135	/ 165	x 12	MA 21
135	/ 165	x 15	MA 21
135	/ 165	x 15	MA 22
135	/ 165	x 18	MA 21
139,7	/ 152,4	x 6,35	MA 23
140	/ 150	x 5	MA 25
140	/ 154	x 10	MA 21
140	/ 155	x 15	MA 25
140	/ 160	x 8	MA 21
140	/ 160	x 10	MA 22
140	/ 160	x 12	MA 25
140	/ 160	x 12	MA 30
140	/ 160	x 14	MA 24
140	/ 160	x 14,5	MA 36
140	/ 160	x 15	MA 23
140	/ 160	x 15	MA 25
140	/ 160	x 15	MA 28
140	/ 160	x 15	MA 30
140	/ 160	x 15	MA 35
140	/ 165	x 18	MA 21
140	/ 165	x 18	MA 22
140	/ 170	x 15	MA 21
140	/ 170	x 15	MA 22
140	/ 170	x 18	MA 21
143	/ 151	x 13	MA 36
145	/ 153	x 6,5	MA 36
145	/ 160	x 8	MA 21
145	/ 160	x 10	MA 23
145	/ 165	x 12	MA 21
145	/ 165	x 15	MA 25
145	/ 170	x 18	MA 21
145	/ 175	x 15	MA 22
145	/ 175	x 18	MA 21
150	/ 170	x 10	MA 22
150	/ 170	x 12	MA 30
150	/ 170	x 13,5	MA 30
150	/ 170	x 15	MA 25
150	/ 170	x 15	MA 28
150	/ 170	x 18	MA 25
150	/ 180	x 15	MA 21

150	/ 180	x 15	MA 22
150	/ 180	x 18	MA 21
150	/ 180	x 18	MA 28
155	/ 163	x 12	MA 21
158,75	/ 190,5	x 19,05	MA 23
160	/ 168	x 12	MA 21
160	/ 175	x 7,5	MA 25
160	/ 180	x 12	MA 23
160	/ 180	x 14	MA 23
160	/ 180	x 15	MA 21
160	/ 180	x 15	MA 25
160	/ 180	x 15	MA 28
160	/ 180	x 15	MA 30
160	/ 185	x 15	MA 30
160	/ 185	x 18,2	MA 36
160	/ 185	x 19	MA 30
160	/ 190	x 15	MA 21
160	/ 190	x 15	MA 22
160	/ 190	x 22	MA 21
160	/ 195	x 17	MA 21
160	/ 200	x 20	MA 21
160	/ 200	x 20	MA 22
165,5	/ 173	x 9	MA 35
168	/ 180	x 14	MA 21
170	/ 190	x 15	MA 25
170	/ 200	x 15	MA 21
170	/ 200	x 18	MA 25
170	/ 200	x 18	MA 28
170	/ 200	x 20	MA 21
170	/ 200	x 22	MA 21
170	/ 200	x 22,7	MA 28
170	/ 210	x 20	MA 22
170	/ 210	x 22	MA 21
180	/ 200	x 14	MA 23
180	/ 200	x 15	MA 25
180	/ 200	x 15	MA 28
180	/ 200	x 15	MA 30
180	/ 205	x 15	MA 30
180	/ 210	x 15	MA 21
180	/ 210	x 22	MA 22
180	/ 220	x 20	MA 22
180	/ 220	x 22	MA 21
185	/ 195	x 12	MA 21
185	/ 200	x 7,5	MA 25
185	/ 200	x 9	MA 21
185	/ 200	x 9,6	MA 28
190,5	/ 222,25	x 19,05	MA 23
190	/ 210	x 15	MA 21
190	/ 210	x 15	MA 25
190	/ 210	x 15	MA 30
190	/ 220	x 15	MA 21
190	/ 220	x 15	MA 22
190	/ 220	x 18	MA 28
190	/ 220	x 22	MA 21
190	/ 220	x 25	MA 21
195	/ 225	x 15	MA 21
195	/ 225	x 15	MA 22
200	/ 220	x 15	MA 25
200	/ 220	x 15	MA 28
200	/ 230	x 15	MA 21
200	/ 230	x 17	MA 25
200	/ 230	x 22	MA 21
200	/ 240	x 20	MA 21
205	/ 235	x 18	MA 25
210	/ 240	x 18	MA 25
210	/ 250	x 20	MA 21
210	/ 250	x 20	MA 22
215,9	/ 247,65	x 19,05	MA 23
215	/ 230	x 7,5	MA 21
220	/ 250	x 18	MA 21

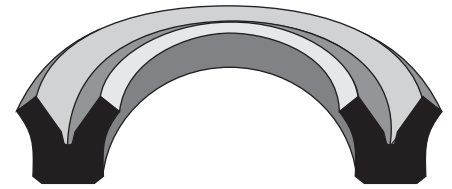

220 / 250 x 18				550 / 600 x 25							
d	/ D	x h	typ								
220	/ 250	x 18	MA 28	255	/ 290	x 20	MA 21	340	/ 380	x 20	MA 21
220	/ 250	x 20	MA 21	260	/ 300	x 20	MA 21	340	/ 380	x 20	MA 22
220	/ 260	x 20	MA 21	260	/ 300	x 20	MA 22	342	/ 355	x 22	MA 21
225	/ 250	x 18	MA 21	270	/ 300	x 20	MA 21	350	/ 400	x 25	MA 21
230	/ 250	x 14	MA 23	270	/ 300	x 22	MA 21	360	/ 420	x 30	MA 21
230	/ 260	x 22	MA 21	280	/ 210	x 15	MA 21	375	/ 395	x 12	MA 21
230	/ 270	x 20	MA 21	280	/ 300	x 14	MA 21	375	/ 400	x 22	MA 21
230	/ 270	x 20	MA 22	280	/ 320	x 20	MA 21	400	/ 430	x 15	MA 22
240	/ 260	x 16	MA 21	300	/ 320	x 15	MA 22	400	/ 450	x 25	MA 21
240	/ 270	x 18	MA 21	300	/ 325	x 20	MA 21	400	/ 450	x 25	MA 22
240	/ 280	x 20	MA 21	300	/ 330	x 20	MA 21	420	/ 440	x 20	MA 21
240	/ 280	x 20	MA 22	300	/ 330	x 22	MA 21	420	/ 450	x 20	MA 21
250	/ 275	x 12	MA 21	300	/ 340	x 20	MA 21	450	/ 500	x 25	MA 21
250	/ 290	x 20	MA 21	300	/ 340	x 20	MA 22	450	/ 500	x 25	MA 22
255	/ 275	x 20	MA 21	310	/ 350	x 15	MA 21	470	/ 490	x 20	MA 21
255	/ 280	x 20	MA 21	320	/ 350	/ 22	MA 21	470	/ 500	x 20	MA 21
255	/ 285	x 20	MA 21	320	/ 360	x 20	MA 21	550	/ 600	x 25	MA 21
				335	/ 367	x 24	MA 21				